

EPSON

Digital Camera

Getting Started

Taking Pictures

Viewing and Managing Your Photos

Making Camera Settings

Using Images on Your Computer

Camera Options and Accessories

Maintenance and Troubleshooting

Specifications

Icons That Appear on the LCD Monitor



PhotoPC **2100Z** *User's Guide*

4014713-00
XXX

Where to Find Information

This User's Guide

Provides detailed information to help you set up and use your EPSON PhotoPC 2100Z, and the optional products available from EPSON. Also contains information on troubleshooting and installing the software on the PhotoPC 2100Z Software CD-ROM included with your PhotoPC 2100Z.

Online EPSON Digital Camera Software User's Guide

Included in the PhotoPC 2100Z Software CD-ROM, this guide provides information on installing and using the EPSON Photo!4 software, which allows you to download photos from your camera to your computer and to manage your photos. Includes instructions for the other software utilities included on the software CD-ROM, such as EPSON AutoDownloader which helps you download files in a quick and organized way. Also includes information on contacting customer support.

Online EPSON PhotoQuicker Reference Guide

This guide provides information on using the EPSON PhotoQuicker software to print your photos. This guide is installed on your computer when you install the EPSON PhotoQuicker software.

Online Help

Provides detailed information and instructions for using EPSON Photo!4 and EPSON AutoDownloader. Online help is automatically installed when you install EPSON Photo!4. See the online *EPSON Digital Camera Software User's Guide* for details on accessing online help.

EPSON®

PhotoPC™
2100Z

DIGITAL CAMERA



Printed on Recycled Paper.

User's Guide

IMPORTANT NOTICE

All rights reserved. No part of this publication may be reproduced, stored in a retrieval system, or transmitted in any form or by any means, electronic, mechanical, photocopying, recording, or otherwise, without the prior written permission of SEIKO EPSON CORPORATION. No patent liability is assumed with respect to the use of the information contained herein. Neither is any liability assumed for damages resulting from the use of the information contained herein.

Neither SEIKO EPSON CORPORATION nor its affiliates shall be liable to the purchaser of this product or third parties for damages, losses, costs, or expenses incurred by the purchaser or third parties as a result of: accident, misuse, or abuse of this product or unauthorized modifications, repairs, or alterations to this product, or (excluding the U.S.) failure to strictly comply with SEIKO EPSON CORPORATION's operating and maintenance instructions.

SEIKO EPSON CORPORATION shall not be liable against any damages or problems arising from the use of any options or any consumable products other than those designated as Original EPSON Products or EPSON Approved Products by SEIKO EPSON CORPORATION.

EPSON is a registered trademark of SEIKO EPSON CORPORATION. PhotoPC is a trademark of SEIKO EPSON CORPORATION. Macintosh is a registered trademark of Apple Computer, Inc. Microsoft and Windows are registered trademarks of Microsoft Corporation. CompactFlash is a trademark of SanDisk Corporation and has been licensed to CFA (CompactFlash Association).

General Notice: Other product names used herein are for identification purposes only and may be trademarks of their respective owners. EPSON disclaims any and all rights in those marks.

Copyright © 2001 by SEIKO EPSON CORPORATION, Nagano, Japan.

This product conforms to the following Directive(s) and Norm(s):

Directive 89/336/EEC:

EN 55022 Class B

EN 55024

A NOTE CONCERNING RESPONSIBLE USE OF COPYRIGHTED MATERIALS

Like photocopiers, digital cameras can be misused by improperly photographing copyrighted material. Unless acting on the advice of a knowledgeable attorney, be responsible and respectful by obtaining the permission of the copyright holder before photographing published material.

Introduction

PhotoPC 2100Z Features	1
Options	3
For United Kingdom users - use of options	4
Safety Instructions	4
When using the camera	4
When using the strap	6
When using the batteries	7
For users in the United Kingdom	8
For users in the United Kingdom, Singapore, and Hong Kong	9
Warnings, Cautions, and Notes	9

Chapter 1 Getting Started

Unpacking Your PhotoPC 2100Z	12
Camera Parts	13
Setting up Your Camera	16
Installing and removing a memory card	16
Installing and replacing the batteries	18
Setting the time and date for the first time	22

Chapter 2 Taking Pictures

Getting Ready to Take Pictures	25
Buttons overview	26
LCD monitor overview	26
Turning the camera on and off	27

Taking Pictures Using the LCD monitor	31
Setting the flash	33
Using the optical and digital zoom features	35
Using the self timer	36
Taking close-ups using the macro setting	38
Taking pictures against a bright background	39
Taking high-resolution photos using the HyPict feature	40
Taking pictures to share over the Internet	42
Taking pictures in low-light conditions	44
Using the white balance feature	46
Taking Pictures Using the Viewfinder	47
Setting the flash	49
Using the optical zoom feature	51
Making other settings	52

Chapter 3 Viewing and Managing Your Photos

Viewing Your Photos on the LCD Monitor	53
Displaying your photos	53
Displaying nine photos at once	54
Magnifying photos	55
Deleting Photos	56
Deleting individual photos	56
Deleting all of the photos	57
Making Print Settings	58
Selecting photos and specifying the number of prints	60
Making the print brightness setting	61
Resetting the number of prints to zero	62

Chapter 4 Making Camera Settings

Setting the Time and Date	65
Changing the time and date setting	65
Changing the display order	67
Setting the Beep.	69

Chapter 5 Using Images on Your Computer

System Requirements.	71
For Windows	72
For Macintosh.	72
Included Software.	73
Installing the Software.	74
Viewing the Software User's Guides on Your Computer.	75
Accessing the EPSON Digital Camera Software User's Guide	75
Accessing the EPSON PhotoQuicker User's Guide	77
Connecting and Disconnecting the Camera	77
Connecting the camera to your computer	78
Disconnecting the camera from your computer	82

Chapter 6 Camera Options and Accessories

Using Memory Cards	85
Inserting a memory card into your computer	86
Copying files directly from the memory card	88
Formatting memory cards	89
Using Rechargeable Batteries.	91
Using the AC Adapter	93

Chapter 7 Maintenance and Troubleshooting

Maintaining the Camera	97
Handling the camera	98
Cleaning the camera	98
Storing the camera	99
Maintaining the Batteries	99
Cleaning the batteries.	99
Storing the batteries	100
Disposing of batteries.	101
Problems and Solutions	102
Camera problems	102
Picture problems	108

Appendix A Specifications

Camera	113
Physical dimensions	113
Product type	114
Recorded image	115
Optical	116
Functional	117
Interface	118
Power	118
PCMCIA Adapter	120
Optional AC Adapter	121

Appendix B Icons That Appear on the LCD Monitor

When Taking Pictures	123
With the tool box open	124
With the bag open	125
When using the zoom feature	125
When specifying the amount of prints after taking a picture.	126
When Viewing Photos	126
With the tool box open	127
When magnifying a photo	128
When there are no photos in the memory card.	128
When specifying the amount of prints	129
When selecting zero prints	130

When Making Camera Settings	131
Camera setting menu	131
When setting the date and time	132
When formatting the memory card	132
Status and Error Icons	133

Glossary

Index

Introduction

Your EPSON® PhotoPC™ 2100Z is a fun, easy-to-use digital camera that enables you to take full-color pictures that you can edit and print using your computer.

Colorful icons on the LCD monitor make the camera easy and fun to use for the whole family.

Create interesting lifelike images to print and share with your family and friends. Add color and visual appeal to your letters, postcards, and cooking recipe cards. Share your photos with world through e-mail and on the Internet.

The PhotoPC 2100Z comes with everything you need to get started, including EPSON Photo!4 software that lets you transfer pictures from the camera to your computer's hard disk. You can then edit, enhance, and organize your pictures, and use them in various applications. For instructions on using and installing EPSON Photo!4, see the online *EPSON Digital Camera Software User's Guide*.

PhotoPC 2100Z Features

The PhotoPC 2100Z has the following features.

- 2.18 megapixels
- 24-bit color image capture

- ❑ High resolution output, up to 2160×1440 pixels when using HyPict
- ❑ PRINT Image Matching support, which allows you to achieve enhanced results when printing your photos with a printer that supports the PRINT Image Matching system
- ❑ Built-in color LCD monitor for previewing and viewing photos
- ❑ Macro photo format
- ❑ Optical $\times 2$ and digital $\times 2.5$ zoom
- ❑ Automatic or predefined white balance adjustment
- ❑ Automatic date and time recording for each photo
- ❑ Built-in flash with automatic flash, red-eye reduction, and flash off options
- ❑ Self-timer (ten second delay)
- ❑ Automatic shut-off to save battery power
- ❑ EPSON Photo!4 software to transfer photos to your computer and manage them
- ❑ EPSON AutoDownloader to help you organize your downloads
- ❑ DPOF file format support, which lets you specify in advance which photos to print and how many prints of each photo to make
- ❑ File formats compatible with both Windows[®] and Macintosh[®] applications

Options

The following options are available from EPSON for the PhotoPC 2100Z.

- CompactFlash™ memory card
(For information, contact your EPSON dealer.)
- AC Adapter (B867081, B867091, B867101, B867111, B867121, B867131, B867141, B867151, B867161, B867171)
for use with a standard electrical outlet
- Power Pack (B81817*, B818181, B818182) which includes:
Ni-MH Battery Charger
Four Ni-MH Rechargeable Batteries
- Package of four Ni-MH Rechargeable Batteries (B81811*)

Note:

- The asterisk acts as a substitute for the last digit of the product number, which varies by country.*
- The PhotoPC 2100Z comes with an 8 MB CompactFlash memory card. For details on using this option, see "Using Memory Cards" on page 85.*
- The AC Adapter model EU-40 and Battery Charger model EU-38 conform to CE marking requirements in accordance with EC Directives 73/23/EEC and 89/336/EEC.*

For United Kingdom users - use of options

EPSON (UK) LTD shall not be liable against any damage or problems arising from the use of any options or consumable products other than those designated as Original EPSON Products or EPSON Approved Products by EPSON (UK) LTD.

Safety Instructions

Read all of these instructions before using the camera, and keep this guide handy for later reference. Follow all warnings and instructions marked on the camera and options.

When using the camera

Note the following when using the camera.

- To reduce the risk of electric shock, do not remove the cover of the camera or options. Do not open any compartments except as instructed in this *User's Guide*.
- Do not insert objects into any openings.
- To prevent fire or electric shock, do not expose the camera or options to rain or moisture.
- To prevent fire or electric shock, do not cover the camera with a blanket or other covering that may give off an electric charge.

- ❑ To prevent fire or explosion, do not use the camera where flammable or volatile gas is stored.
- ❑ Do not use the camera outdoors during a thunderstorm.
- ❑ If the camera or optional equipment emits unusual noises, odors, or smoke, cancel the current operation and turn the device off immediately. Remove the batteries and/or disconnect the AC adapter from the camera, then unplug the AC adapter from the electrical outlet. Then contact your EPSON dealer.
- ❑ To prevent possible injury, do not take flash pictures in close proximity to anyone's eyes.
- ❑ Only use the type of power source specified in this *User's Guide*.
- ❑ Do not use damaged or frayed power cords.
- ❑ Remove the batteries and/or plug from the camera and refer servicing to qualified service personnel in the following circumstances:

The power cord or plug is damaged; liquid has entered the camera or options; the camera or optional equipment have been dropped or the case is damaged; the camera or optional equipment do not operate normally or exhibit a distinct change in performance.
- ❑ Never adjust controls that are not mentioned in the operating instructions.

- ❑ If you plan to use the camera and optional equipment in Germany, observe the following:

To provide adequate short-circuit protection and over-current protection for these products, the building installation must be protected by a 10 or 16 Amp circuit breaker.

Bei Anschluss des Produkts an die Stromversorgung muss sichergestellt werden, dass die Gebäudeinstallation mit einem 10 A- oder 16 A-Sicherung abgesichert ist.

- ❑ If the liquid crystal solution contained in the display panel or in the LCD monitor leaks out and gets on your hands, wash them thoroughly with soap and water. If it gets into your eyes, flush them immediately with water.
- ❑ Do not look at the sun through the viewfinder. Doing so could damage your eyes.

When using the strap

Note the following when using the camera strap.

- ❑ Do not swing the camera about. Doing so could damage the camera or other objects, or cause injury.
- ❑ Do not pull or tighten the strap too much when wearing it. Doing so could cause serious injury.
- ❑ Keep the strap away from children.

When using the batteries

Note the following when using batteries.

- Read all relevant safety and operating instructions before using the batteries.
- Do not use manganese batteries (IEC R6).
- Do not charge primary (non-rechargeable) batteries.
- To avoid fire or electric shock, do not use batteries that are leaking or damaged in any way.
- Be aware of electrical shock hazards.
- Do not handle the batteries with wet hands or use them near water.
- Do not expose the batteries to water or high humidity.
- Keep batteries away from heat sources.
- Do not drop, puncture, disassemble, mutilate, or short-circuit batteries.
- Do not place the batteries near or into fire or water.
- To protect against short-circuiting, do not remove the outside sleeves of the batteries.
- Do not insert objects into any openings, as they may touch dangerous voltage points or short-circuit components.
- Prevent the batteries from coming into contact with metal objects which could short-circuit the batteries, such as coins or keys.

- ❑ Do not insert batteries into wall outlets or other power sources such as car cigarette lighter sockets.
- ❑ Do not solder lead wires or terminals directly to a battery.
- ❑ If battery acid gets into your eyes or on your skin, immediately rinse the affected area thoroughly with water and seek medical treatment. If a battery is swallowed, seek medical treatment immediately.

For users in the United Kingdom



Warning:

This appliance must be earthed. Refer to the rating plate for the voltage, and check that the appliance voltage corresponds to the supply voltage.

Important:

The wires in the mains lead fitted to this appliance are coloured in accordance with the following code:

Green and yellow — Earth

Blue — Neutral

Brown — Live

As the colours of the wires in the mains lead of this appliance may not correspond with the coloured markings identifying the terminals in your plug, proceed as follows:

- ❑ The green and yellow wire must be connected to the terminal in the plug which is marked with the letter E or with the earth symbol (\perp).
- ❑ The blue wire must be connected to the terminal in the plug marked with the letter N.
- ❑ The brown wire must be connected to the terminal in the plug marked with the letter L.

For users in the United Kingdom, Singapore, and Hong Kong

If damage occurs to the plug, replace the cord set or consult a qualified electrician.

Replace fuses only with fuses of the correct size and rating.

Warnings, Cautions, and Notes



Warnings must be followed carefully to avoid bodily injury.



Cautions must be observed to avoid damage to your equipment.

Notes contain important information and useful tips for the operation of your camera and options.

Getting Started

This chapter helps you to set up your PhotoPC 2100Z and covers the following topics:

- ❑ Unpacking your PhotoPC 2100Z
- ❑ Getting familiar with the camera parts
- ❑ Installing the CompactFlash memory card
- ❑ Installing and replacing batteries
- ❑ Setting the time and date

Unpacking Your PhotoPC 2100Z

Make sure that your camera box contains all of the items shown below.

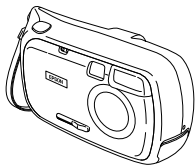

camera



CD-ROM
(quantity varies by location)

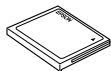

8 MB CompactFlash
memory card
(installed in the camera)

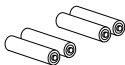

alkaline batteries (4)



USB cable

Camera Parts

After unpacking your PhotoPC 2100Z, take a few minutes to learn about the components shown below.

Front

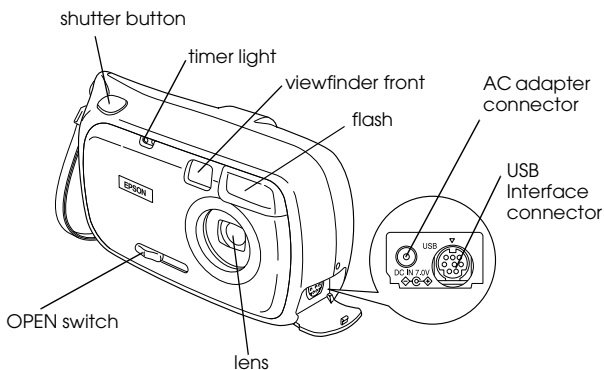

Back

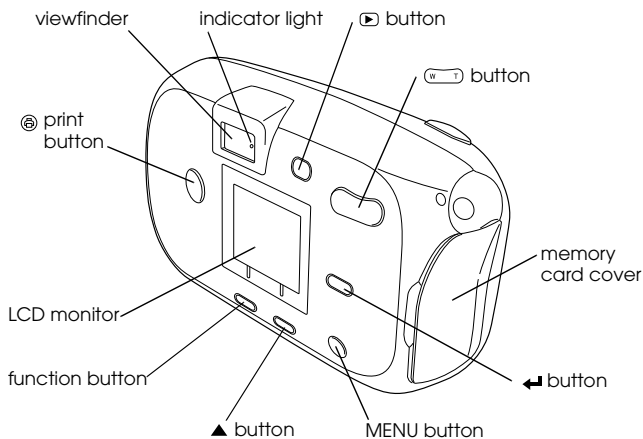

Bottom

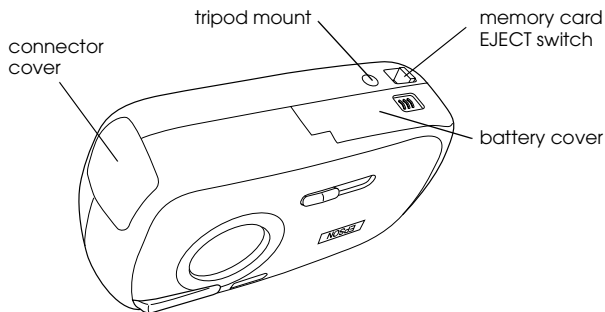

Indicator lights

The camera has an indicator light beside the viewfinder. It turns on and blinks in different colors to guide you through the picture-taking process, or to indicate the status of the camera. See below for details.

Light	Indication
Green (On)	The camera is warmed up and ready for taking pictures.
Green (Blinking)	The camera is warming up (immediately after camera is turned on). The camera is auto focussing (when shutter button is pressed halfway). The camera is changing the settings. The camera is processing an image. The camera is communicating with the computer. The flash is warming up.
Orange (On)	The LCD monitor has turned off automatically to save power.
Orange (Blinking)	The camera is on and connected to the computer. The camera has automatically shut off to save power.

Red (Blinking)	A memory card is not inserted. Insufficient space in memory card to take a picture. Low battery.
Red (On)	Error. Try to turn the camera off and back on. If the red light is still on, contact your EPSON dealer for servicing.

Setting up Your Camera

This section explains how to install the batteries and a memory card in your camera, and set the time and date for setup. Replacing the batteries is also explained.

Installing and removing a memory card

You cannot take pictures unless a CompactFlash memory card is inserted in your camera.

Your camera comes with a memory card already inserted. If you need to remove or insert the memory card, follow these steps.

1. Make sure the lens cover is closed and the indicator light next to the viewfinder is off.

**Caution:**

Never remove or insert a memory card while the camera is on. The card may be damaged and the data in the card may be lost.

2. Open the memory card cover.

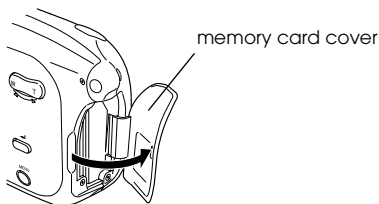

3. To insert the card, make sure that the front of the card and the back of the camera are facing the same direction, then insert the card all the way into the memory card slot.

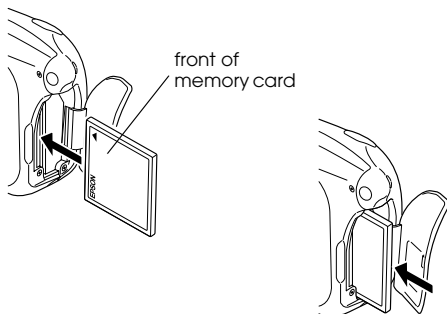

To remove the card, slide the EJECT switch on the bottom of the camera. Then, remove the card and close the cover.

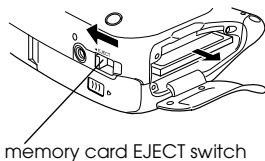

Caution:

- Never remove a memory card while the camera is on. Doing so may cause data in the card to be lost or damaged.*
- Avoid using or storing the card in direct sunlight, or in places that are extremely hot, humid, or dusty.*
- For detailed information on the optional memory card, see "Using Memory Cards" on page 85.*

Installing and replacing the batteries

Your PhotoPC 2100Z comes with four AA (IEC LR6) alkaline batteries. See the following sections for details on installing and replacing them. See "Maintaining the Batteries" on page 99, for information on cleaning, storing, and disposing of the batteries.

**Caution:**

- ❑ Do not use manganese batteries (IEC R6).
- ❑ Always use batteries from the same package. Do not mix old and new batteries.
- ❑ Be sure to turn the camera off before removing the batteries.

Note:

- ❑ Do not leave batteries in the camera for a long time without using it. See “Storing the batteries” on page 100 for storage instructions.
- ❑ You can also use optional Ni-MH rechargeable batteries (Model EU-24). For more information on rechargeable batteries, see “Using Rechargeable Batteries” on page 91.

Installing the batteries

Before installing the batteries, be sure to read the safety instructions outlined in “When using the batteries” on page 7.

Make sure that the camera is turned off as shown below (the lens cover is not open) and the indicator light next to the viewfinder is off. Follow the steps below to install or replace the batteries.

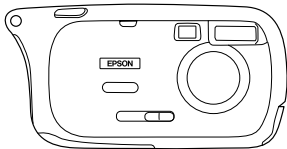

1. Turn the camera upside down with the lens facing you. Slide and open the battery cover as shown below.

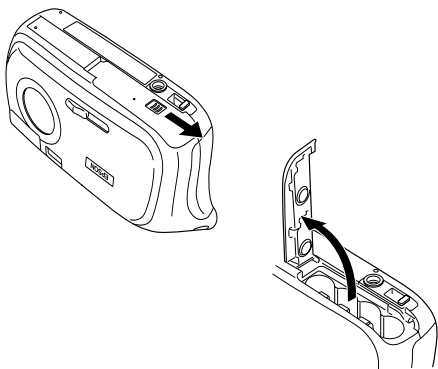

2. Insert four batteries into the compartment, positioning the + and - ends as shown below.

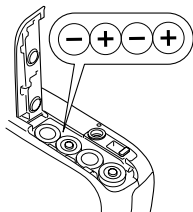



Warning:

- Do not use different types of batteries together. Doing so could cause fire or explosion.
- Do not carry loose batteries in your pockets.

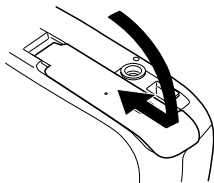
3. Lower the battery cover shut and hold it down while you slide and lock it, as shown below.





Replacing the batteries



If the batteries are almost out of power, the , , and  icons appear in turn on the LCD monitor or the camera makes a sound, or both. If the batteries are out of power, the camera turns off automatically. Be sure to replace all four batteries at the same time. Use either of the following battery types.

Single-use AA (IEC LR6) alkaline batteries

Rechargeable AA Ni-MH batteries

Note:

- ❑ *The battery status is always displayed at the top right corner of the LCD monitor.*
 -  *Indicates sufficient battery power.*
 -  *Indicates moderate battery power. Make sure you have new batteries on hand.*
 -  *Indicates low battery power. Replace with new batteries.*
- ❑ *If the batteries are not clean, the camera may not work correctly. See “Cleaning the batteries” on page 99.*

- ❑ *When the , , and  icons appear in turn, all buttons are disabled.*
- ❑ *Battery life varies depending on battery type and manufacturer.*
- ❑ *If you use rechargeable Ni-MH batteries in the PhotoPC 2100Z, make sure that all four batteries are fully charged when you replace them. If you find that your batteries run out soon after recharging them a number of times, make sure that you discharge the batteries completely before recharging them.*
- ❑ *Ni-MH rechargeable batteries with a battery charger can be purchased from EPSON.*

Now you are ready to turn on the camera.

Setting the time and date for the first time

Follow the steps below to set the time and date the first time you turn on the camera.

Note:

- ❑ *If you remove the batteries from the camera, the time and date settings will be erased after approximately four days (after using the camera for at least one day).*
- ❑ *If the time and date settings are erased, the date and time appear on the LCD monitor as shown in step 2 below. Follow the instructions from step 2 to make the settings again.*

1. Slide the OPEN switch in the direction shown below to turn the camera on.

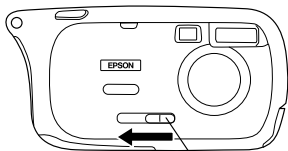

Slide the OPEN switch in the direction of the arrow to turn the camera on.

2. The date and time appear on the LCD monitor as shown on the right. The month, day, and year are displayed with the month highlighted.

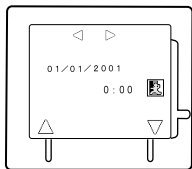

3. Press the function button and the ▲ button to change the value of the highlighted item.
4. After you finish making settings, highlight a different item by pressing W and T on the (W T) button.
5. Repeat steps 3 and 4 until you finish making the date and time settings.

6. After you are finished making the date and time settings, press the  button.

Note:

To change the setting, or the order that the date is displayed, see “Setting the Time and Date” on page 65.

You are now ready to take pictures. See the next chapter for instructions on taking pictures.

Using the PhotoPC 2100Z to take pictures is similar to using a traditional “point and shoot” camera. This chapter explains how to take pictures with the LCD monitor and the viewfinder, and how to use the camera’s picture-taking features.

Getting Ready to Take Pictures

This section gives you an overview of the camera’s buttons and LCD monitor, and explains how to turn your camera on and off.

Note:

EPSON is not responsible for any photos you may lose while using our products and software. Make sure that your camera is working normally before taking important pictures.

Buttons overview

There are seven buttons on the back of your PhotoPC 2100Z. These buttons are for making various settings and for using the different features of the camera.

In this user's guide, the buttons are named as follows.

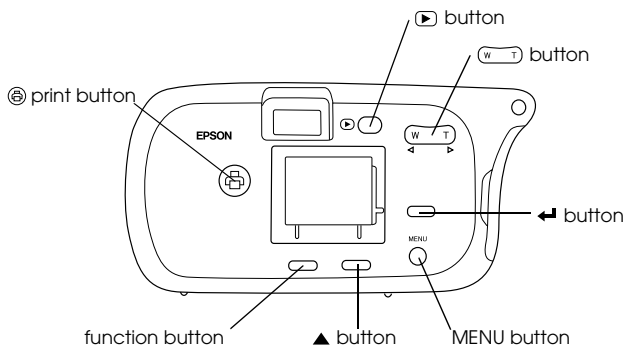

LCD monitor overview

You can use the LCD monitor to see an image preview when taking pictures, viewing the pictures you took, and to make various settings.

At certain times, icons and other indicators appear in the LCD monitor as shown below. For more information, see “Taking Pictures Using the LCD monitor” on page 31.

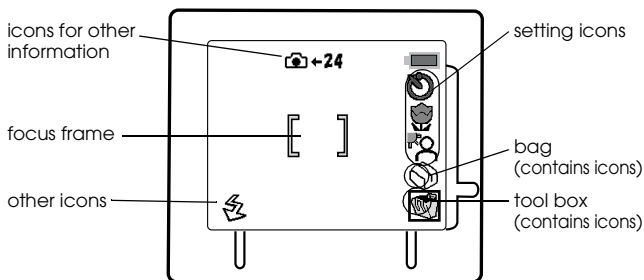

Turning the camera on and off

Read the following sections to turn the camera on and off.

Turning the camera on

There are two ways to turn the camera on depending on whether you want to take pictures or view those you have previously taken.

Note:

Be sure the memory card is installed in the camera before turning the camera on. For installation instructions, see “Installing and removing a memory card” on page 16.

To take pictures, slide the OPEN switch in the direction shown below.

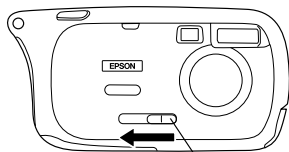

Slide the OPEN switch in the direction of the arrow to turn the camera on.

The lens extends and the indicator light next to the viewfinder on the back of the camera briefly blinks green, and then stays on. A live preview image appears on the LCD monitor.

To view pictures you have previously taken, press the  button on the back of the camera. The indicator light next to the viewfinder briefly blinks green and then stays on. The LCD monitor shows the picture you took last. For more information on playing back your photos, see "Viewing Your Photos on the LCD Monitor" on page 53.

Note:

- ❑ *If the following appears on the LCD monitor when you turn the camera on, see “Setting the time and date for the first time” on page 22.*

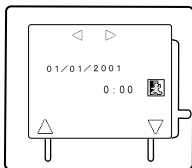

- ❑ *If the following icons appear on the LCD monitor after you press the  button, there are no photos saved in the camera's memory card.*



- ❑ *Once the lens cover is open and the camera is on, you can press the  button to switch between taking new pictures and viewing photos saved in the memory card.*

Turning the camera off

To turn the camera off, first slide the OPEN switch in the direction shown below, if necessary.

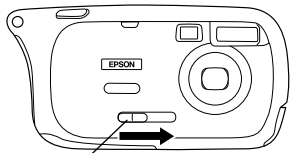

Slide the OPEN switch in the direction of the arrow to turn the camera off.

If the LCD monitor or the indicator light next to the viewfinder remains on, press the  button on the back of the camera once. The LCD monitor turns off and the indicator light next to the viewfinder on the back of the camera briefly blinks and then goes off.

Automatic shut-off feature

Your camera saves battery power by shutting off when idle for a certain period of time. Before the camera shuts off, the **3**, **2**, and **1** icons appear in succession on the LCD monitor, then the LCD monitor turns off. Depending on the amount of time the camera is idle, the indicator light goes off, and the lens retracts.

To turn the camera back on when the lens is extended, press any button on the camera. The camera returns to the status it was in before it automatically shut off.

To turn the camera back on when the lens is retracted, either press the  button or slide the OPEN switch to open the lens cover. Otherwise, slide the OPEN switch to close the lens cover, then slide it again to open the lens cover and turn the camera back on.

Note:

If the camera is connected to a computer, the automatic shut-off feature does not turn the camera off automatically.

Taking Pictures Using the LCD monitor

By using the LCD monitor, you can get a good idea of what the image will look like before taking pictures and confirm image quality immediately after taking pictures. Use the LCD monitor when you want to take pictures using the digital zoom feature or the macro setting.

Follow these steps to take pictures using the LCD monitor.

1. Slide the OPEN switch to extend the lens. A live preview appears on the LCD monitor. Center the subject of your photo in the LCD monitor.

Note:

- You can turn the LCD monitor's icon display off by pressing the MENU button once. To turn the icon display back on, press the MENU button twice.
- Hold the camera steadily with both hands and keep it still for a few moments after you press the shutter button.

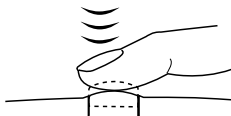

- ❑ *Make sure that you are not blocking the areas around the lens, flash, and timer light with your finger, the strap, clothing, or other objects.*

2. Hold the shutter button halfway down to lock the auto focus. The focus is locked when the indicator light next to the viewfinder stops blinking and the focus frame on the LCD monitor changes from white to green. If you wish, you can now reposition the subject off-center while keeping it in focus.



3. Hold the camera still while depressing the shutter button fully to take the picture. Then release the shutter button.



After you take the picture,  appears on the bottom left of the LCD monitor and the indicator light next to the viewfinder blinks. At this time, you can specify the number of prints by pressing the  print button. To take another picture, press the function button, then repeat steps 2 and 3.

Note:

For more information on specifying the number of prints, see “Making Print Settings” on page 58.

After you are finished taking pictures, you can view the pictures you took, delete them, and make print settings. See Chapter 3, “Viewing and Managing Your Photos”.

Setting the flash



You can choose between three flash settings: Flash Auto, Flash Off, and Red-eye Reduction. To change the setting, follow the steps below.

1. Turn on the camera by sliding the OPEN switch to open the lens cover.

Note:

For more information on turning on the camera, see “Turning the camera on and off” on page 27.

2. Press the function button repeatedly under the flash setting icon to select the appropriate icon. See the table below for function descriptions.

Flash Auto		The flash fires whenever more lighting is needed.
Flash Off		The flash does not fire even when more lighting is needed. Use this setting for special effects or when using a flash is prohibited.
Red-eye Reduction		Before firing, the flash flickers briefly to reduce the red-eye effect. The flash only fires whenever more lighting is needed.

3. Once you are finished setting the flash, take a picture.

Using the optical and digital zoom features

You can capture a smaller portion of your subject at a higher magnification using the zoom feature. When taking pictures with the LCD monitor, you can use the digital zoom in addition to the optical zoom to seamlessly magnify the image by as much as five times.

1. Turn on the camera by sliding the OPEN switch to open the lens cover.

Note:

For more information on turning on the camera, see "Turning the camera on and off" on page 27.

2. Press T on the (W T) button to zoom in on your subject, and W to zoom out.
3. The green and yellow bars indicate the current zoom status, moving to the right when you press T on the (W T) button to zoom in, and to the left when you press W to zoom out. To use the digital zoom feature, hold down the T on the (W T) button until the yellow bar appears. A yellow frame appears around the previewed image.

The diagram shows a rectangular LCD monitor with two small feet at the bottom. At the top of the monitor, there are two horizontal bars: a green bar on the left and a yellow bar on the right. Lines with labels 'green bar' and 'yellow bar' point to these respective bars. The yellow bar is enclosed in a yellow rectangular frame. Below the monitor, a text box explains the yellow bar's function.

The yellow bar indicates that the digital zoom feature is being used.

4. Frame your subject in the LCD monitor and take a picture.

Note:

- ❑ You cannot use the digital zoom feature when taking pictures using the viewfinder.
- ❑ Photos taken using the digital zoom feature take more time to be processed.

Using the self timer



You can take a picture of yourself easily by using the self timer. The self timer creates a 10-second delay between the time you press the shutter button and the time the picture is taken. Follow the steps below.

1. Turn on the camera by sliding the OPEN switch to open the lens cover.

Note:

For more information on turning on the camera, see “Turning the camera on and off” on page 27.

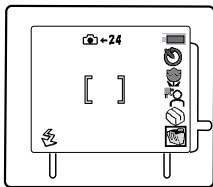

2. Press the ▲ button. The  tool box opens, other icons appear above it, and a red frame appears around the tool box.



3. Press the ▲ button repeatedly until the red frame appears around the  icon.



Select this icon with the red frame.

4. Press the  button. The  icon moves to the left side of the LCD monitor.

Note:

To cancel this setting, press the  button again. The icon goes back to the right.

5. Press the shutter button to start the self timer. The camera beeps and icons appear on the LCD monitor to indicate the countdown, and the red timer light on the front of the camera starts blinking.

Note:

To cancel the self timer setting, press the shutter button or slide the OPEN switch to close the lens cover during the countdown.

If you want the camera to be silent during the countdown, see “Setting the Beep” on page 69 to turn off the camera’s sound.

6. A picture is taken automatically after the countdown ends.

Note:

You can take pictures using the viewfinder instead of the LCD monitor. See “Taking Pictures Using the Viewfinder” on page 47.

Taking close-ups using the macro setting



Use the macro feature for taking close-ups. This setting allows you to take pictures of subjects 30 to 50 centimeters away from the camera.

1. Turn on the camera by sliding the OPEN switch to open the lens cover.

Note:

For more information on turning on the camera, see "Turning the camera on and off" on page 27.

2. Press the ▲ button. The  tool box opens, other icons appear above it, and a red frame appears around the tool box.

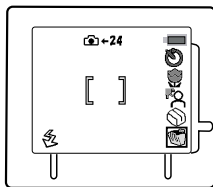

3. Press the ▲ button repeatedly until the red frame appears around the  macro icon.



Select this icon with the red frame.

4. Press the ◀ button. The  macro icon moves to the left side of the LCD monitor, and the LCD monitor becomes enclosed in a green frame.

Note:

To cancel this setting, press the ◀ button again. The icon goes back to the right.

5. Once you are finished making the setting, take a picture.

Note:

You cannot use the macro feature when taking pictures using the view finder.

Taking pictures against a bright background

If the background is excessively bright, use the backlight setting to avoid making the subject of the photo appear too dark. Follow the steps below.

1. Turn on the camera by sliding the OPEN switch to open the lens cover.

Note:

For more information on turning on the camera, see “Turning the camera on and off” on page 27.

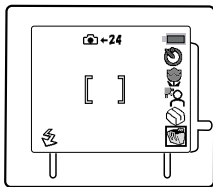

2. Press the ▲ button. The  tool box opens, other icons appear above it, and a red frame appears around the tool box.



3. Press the ▲ button repeatedly until the red frame appears around the  icon.



Select this icon with the red frame.

4. Press the  button. The  icon moves to the left side of the LCD monitor.

Note:

To cancel this setting, press the  button again. The icon goes back to the right.

5. Once you are finished making the setting, take a picture.

Note:

You can take pictures using the viewfinder instead of the LCD monitor. See “Taking Pictures Using the Viewfinder” on page 47.

Taking high-resolution photos using the HyPict feature



By default, your PhotoPC 2100Z takes pictures that are fit for printing with a resolution of 1800 × 1200 pixels.

You can also take pictures that have a higher resolution of 2160 × 1440 pixels. These photos have higher detail, and more time is required for your camera or computer to process these photos. To take high-resolution photos, follow the steps below.

Note:

- To take photos with a smaller file size fit for sending over the Internet, see “Taking pictures to share over the Internet” on page 42.*
- To prepare photos for printing, see “Making Print Settings” on page 58.*

1. Turn on the camera by sliding the OPEN switch to open the lens cover.

Note:

For more information on turning on the camera, see "Turning the camera on and off" on page 27.

2. Press the ▲ button. The  tool box opens, other icons appear above it, and a red frame appears around the tool box.

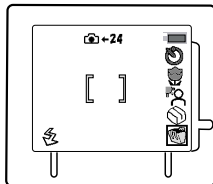

3. Press the ▲ button until the red frame appears around the  bag.



Select this icon with the red frame.

4. Press the ◀ button. The  bag opens and some other icons appear.

5. Press the ▲ button repeatedly until the red frame appears around the  icon.



Select this icon with the red frame.

6. Press the ◀ button. The  icon moves to the left side of the LCD monitor.

Note:

To cancel this setting, press the ◀ button again. The icon goes back to the right.

7. Once you are finished making the setting, take a picture.

Note:

You can take pictures using the viewfinder instead of the LCD monitor. See “Taking Pictures Using the Viewfinder” on page 47.

Taking pictures to share over the Internet



By default, your PhotoPC 2100Z takes pictures that are fit for printing with a resolution of 1800 × 1200 pixels.

You can also take pictures that have a smaller resolution of 720 × 480 pixels, which are ideal for sharing over the Internet via e-mail. To take pictures at this resolution, follow the steps below.

Note:

- ❑ *To take pictures at a higher resolution of 2160 × 1440 pixels, see “Taking high-resolution photos using the HyPict feature” on page 40.*
 - ❑ *You cannot make the settings below when using the HyPict resolution feature. To cancel the HyPict setting, see “Taking high-resolution photos using the HyPict feature” on page 40.*
1. Turn on the camera by sliding the OPEN switch to open the lens cover.

Note:

For more information on turning on the camera, see “Turning the camera on and off” on page 27.

2. Press the ▲ button. The  box opens, other icons appear above it, and a red frame appears around the tool box.

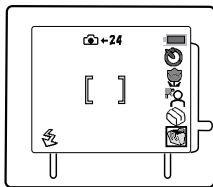

3. Press the ▲ button repeatedly until the red frame appears around the  bag.



4. Press the ◀ button. The  bag opens and some other icons appear.

5. Press the ▲ button repeatedly until the red frame appears around the  icon.



6. Press the ◀ button. The  icon moves to the left side of the LCD monitor

Note:

To cancel this setting, press the ◀ button again. The icon goes back to the right.

7. Once you are finished making the setting, take a picture.

Note:

You can take pictures using the viewfinder instead of the LCD monitor. See "Taking Pictures Using the Viewfinder" on page 47.



Taking pictures in low-light conditions

 Follow the steps below for best results in low-light conditions, such as when taking pictures of a nightscape or under insufficient room light. More time is required to take a picture with this setting.



1. Turn on the camera by sliding the OPEN switch to open the lens cover.

Note:

For more information on turning on the camera, see "Turning the camera on and off" on page 27.

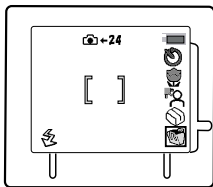
2. Press the  button. The  tool box opens, other icons appear above it, and a red frame appears around the tool box.





3. Press the  button until the red frame appears around the  tool bag.





Select this icon with the red frame.

4. Press the  button. The  bag opens and some other icons appear.

5. Press the  button repeatedly until the red frame appears around the  icon.



Select this icon with the red frame.



6. Press the  button. The  icon moves to the left side of the LCD monitor.

Note:

To cancel this setting, press the  button again. The icon goes back to the right.

7. Once you are finished making the setting, take a picture.

Note:

- If you want to take a picture of a person or persons in a nightscape, set the flash function to  (auto) to capture both the images of your subject and the background. We recommend that you use tripod for stability.*
- Set the flash function to  (off) when you want to capture only the image of a nightscape.*
- You can take pictures using the viewfinder instead of the LCD monitor. See “Taking Pictures Using the Viewfinder” on page 47.*

Using the white balance feature



The EPSON PhotoPC 2100Z adjusts the balance of colors automatically. If you want to make the colors in your photos appear more realistic, use the white balance setting as follows.



For example, turn the white balance setting on when taking pictures at dusk to increase the reddish color tones in your images, or when you want to capture the atmosphere of room lamps or candles. However, to avoid a green tone in your photos, do not turn the white balance setting on when taking pictures under white light.

To turn the white balance setting on, follow the steps below.





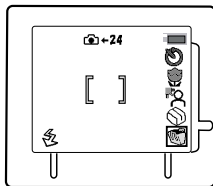

1. Turn on the camera by sliding the OPEN switch to open the lens cover.

Note:

For more information on turning on the camera, see "Turning the camera on and off" on page 27.

2. Press the  button. The  tool box opens, other icons appear above it, and a red frame appears around the tool box.



3. Press the ▲ button repeatedly until the red frame appears around the  tool bag.  Select this icon with the red frame.
4. Press the ◀ button. The  tool bag opens and some other icons appear.
5. Press the ▲ button repeatedly until the red frame appears around the  icon.  Select this icon with the red frame.
6. Press the ◀ button. The  icon moves to the left side of the LCD monitor.

Note:

To cancel this setting, press the ◀ button again. The icon goes back to the right.

7. Once you are finished making the setting, take a picture.

Taking Pictures Using the Viewfinder

Use the viewfinder instead of the LCD monitor when taking pictures to save battery power and hold the camera steady while pressing the shutter button.

Follow the steps below.

1. Turn on the camera by sliding the OPEN switch to open the lens cover. A live preview appears on the LCD monitor.

2. Press the MENU button twice to turn the LCD monitor off.
3. Wait until the indicator light beside the viewfinder comes on.
4. Look straight through the viewfinder and center your subject in the focus frame.

Note:



- ❑ *Hold the camera steadily with both hands and keep it still for a few moments after you press the shutter button.*
- ❑ *Make sure that you are not blocking the areas around the lens, flash, and timer light with your finger, the strap, clothing, or other objects.*
- ❑ *The visible frame in the viewfinder indicates the approximate area that is captured in the photo.*

5. Hold the shutter button halfway down to lock the auto focus. The focus is locked when the indicator light next to the viewfinder stops blinking. If you wish, you can now reposition the subject off-center while keeping it in focus.



6. Hold the camera still while depressing the shutter button fully to take the picture. Then release the shutter button.



After you take the picture, the LCD monitor comes on momentarily, displaying the picture you just took, and  appears on the bottom left of the LCD monitor. At this time, you can specify the number of prints by pressing the  print button. To take another picture, press the function button, then repeat steps 4 through 6.

Note:

- ❑ For more information on specifying the number of prints, see “Making Print Settings” on page 58.
- ❑ After you are finished taking pictures, you can view the pictures you took, delete them, and make print settings. See Chapter 3 “Viewing and Managing Your Photos”.

Setting the flash



You can choose between three flash functions: Flash Auto, Flash Off, and Red-eye Reduction. To change the setting, follow the steps below.

1. Turn on the camera by sliding the OPEN switch to open the lens cover.

Note:

For more information on turning on the camera, see “Turning the camera on and off” on page 27.

2. Press the function button repeatedly under the flash setting icon to select the appropriate icon. See the table below for function descriptions.

Flash Auto		The flash fires whenever more lighting is needed.
Flash Off		The flash does not fire even when more lighting is needed. Use this setting for special effects or when using a flash is prohibited.
Red-eye Reduction		Before firing, the flash flicks briefly to reduce the red-eye effect. The flash only fires whenever more lighting is needed.

3. Once you are finished setting the flash, press the MENU button twice to turn the LCD monitor off.
4. Look through the viewfinder to take the picture.

Using the optical zoom feature

You can capture a smaller portion of your subject at a higher magnification using the zoom feature.

1. Turn on the camera by sliding the OPEN switch to open the lens cover.

Note:

For more information on turning on the camera, see “Turning the camera on and off” on page 27.

2. Press T on the  button to zoom in, and W to zoom out.
3. Once you are finished setting the zoom, press the MENU button twice to turn the LCD monitor off.
4. Look through the viewfinder to take the picture.

Note:

You cannot use the digital zoom feature when taking pictures using the viewfinder. For more information, see “Using the optical and digital zoom features” on page 35.

Making other settings

When taking pictures using the viewfinder, you can use many of the same features that are available when taking pictures using the LCD monitor. To use these features, you must first make settings using the LCD monitor. Once you have made the desired settings, press the MENU button twice to turn off the LCD monitor, and then take pictures using the viewfinder. The settings you made using the LCD monitor will be reflected in the pictures you take using the viewfinder.

See below to find instructions on using the feature of your choice.

Note:

You cannot use the macro or the digital zoom features when taking pictures with the viewfinder

Self timer	See "Using the self timer" on page 36.
Bright background	See "Taking pictures against a bright background" on page 39.
High-resolution	See "Taking high-resolution photos using the HyPict feature" on page 40.
E-mail size	See "Taking pictures to share over the Internet" on page 42.
Low-light	See "Taking pictures in low-light conditions" on page 44.

This chapter explains how to view photos on your camera's LCD monitor. It also includes explanations for deleting photos, and for making print settings.

Viewing Your Photos on the LCD Monitor



See the following sections to view photos on your camera's memory card, follow the steps below.

Displaying your photos

To display the photos saved in the camera's memory card, follow the steps below.

1. Press the  button. The last photo you took is displayed on the LCD monitor.

Note:

- ❑ If a live preview image is displayed, press the  button to view the last photo you took.
- ❑ If the  and  icons appear in turn on the LCD monitor, there are no photos saved in the memory card.

- Press T on the  button to see the next photo, and W to see the previous photo.

Note:

The indicator light blinks green until the photo is displayed.

- To stop viewing the photos, press the  button.

Note:

If the lens on your camera is extended, you can take a picture afterwards. If it is not extended, the camera is off.



Displaying nine photos at once

The PhotoPC 2100Z's monitor can display nine photos at once. To view nine photos at once, follow the steps below.

- Press the  button to display your photos. See "Displaying your photos" on page 53.

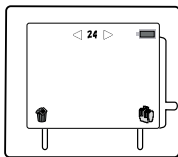
The LCD monitor appears as shown on the right.



- Press the  button repeatedly until the red frame appears around the  icon.







Select this icon with the red frame.

3. Press the  button. After the indicator light blinks green, the LCD shows nine photos.

Note:

To cancel this setting, press the  button again.

4. To select the next photo, press \bar{T} on the  button. For the previous photo, press W.
5. To exit the multi-display, press the  button.

If you make other settings, you can switch back to viewing one photo at a time. Press the  button to select the  icon, then press the  button.



Magnifying photos



You can view a magnified version of the photos saved in your camera on the LCD monitor. Follow the steps below.







1. Press the  button to display your photos. See “Displaying your photos” on page 53.

The last photo you took appears on the LCD monitor.

2. Select the photo you want to magnify using the  button. To select the next photo, press \bar{T} . For the previous photo, press W.
3. Press the  button repeatedly until the red frame appears around the  icon.



Select this icon with the red frame.

4. Press the  button.
5. The  icon appears at the top of the LCD monitor. This icon indicates that the center part of the photo is magnified now.  The white part of this icon shows the magnified part.
6. To change the magnified area, press T (to the right) or W (to the left) on the  button. Press the function button to go up or the  button to go down.
7. To exit the magnified display, press the  button.



Deleting Photos





You can delete one photo or all of the photos at once using the LCD monitor.

Deleting individual photos



To delete photos saved in your memory card one at a time, follow the steps below.

1. Press the  button to display your photos. See “Displaying your photos” on page 53. The last photo you took appears on the LCD monitor.
2. Select the photo you want to delete using the  button. To select the next photo, press T. For the previous photo, press W.

3. Press the function button under the  icon. The , , and  icons appear in turn.
4. Press the  button to delete the selected photo.



Note:

To cancel this setting, press the function button under the  icon.

Deleting all of the photos







To delete all of the photos stored on the memory card in your camera at once, follow these steps.





1. Press the  button to display your photos. See “Displaying your photos” on page 53. The last photo you took appears on the LCD monitor. You can also erase all the data in the memory card by formatting the memory card. See “Formatting memory cards” on page 89.
2. Press the  button repeatedly until the red frame appears around the  icon.



Select this green icon with the red frame.

3. Press the  button. The , , and  icons appear in turn.

Note:

- To cancel the operation, press the  button next to the  icon.
 - You can also erase all the data in the memory card by formatting the memory card. See “Formatting memory cards” on page 89.
4. Press the function button to delete all photos. All photos are deleted and the  and  icons appear in turn to signify that there are no photos in the memory card.

Note:

All photos in the card are deleted, including any photos that were locked using EPSON Photo!4 or a different EPSON camera.

Making Print Settings

You can use your PhotoPC 2100Z to make settings that determine how your photos are printed. After you select which photos you want to print, you can make the following settings:

- The number of prints for each selected photo

The settings for the number of prints are saved in a Digital Print Order Format (DPOF) file on the camera's memory card. You can apply these settings when using a printer or printing application that supports the DPOF standard. Also, in some countries you will find print shops that support this standard and can print according to the settings in your DPOF file. Using the DPOF file to relay these settings to your printer, printing application, or print shop helps make printing quick and easy.

❑ Brightness setting

This brightness setting is recorded in each image file as PRINT Image Matching information. This information can be used by printers that support the PRINT Image Matching system for enhanced printing results.

PRINT Image Matching is a new standard that allows digital cameras to record special information about the photos it takes and relay that information seamlessly to a printer compatible with this standard. Your PhotoPC 2100Z records this special information in each JPEG photo it takes. By using a printer that is also compatible with the PRINT Image Matching system, you can achieve printing results that were previously unattainable.

Note:

PRINT Image Matching information does not change the image data or the way the image is displayed on a computer screen.



To make these settings, see the following sections.

Note:

To print the photos on your memory card, see the online EPSON Digital Camera Software User's Guide.



Selecting photos and specifying the number of prints

You can use the  print button on the back of the camera to select a photo to be printed, and to specify the number of prints. Follow the steps below.

1. Press the  button to display your photos. See “Displaying your photos” on page 53. The last photo you took appears on the LCD monitor.
2. Select the photo you want to make print settings for using the  button. To select the next photo, press T. For the previous photo, press W.

Note:

To make selecting photos easier, you can display nine photos at once. See “Displaying nine photos at once” on page 54.

3. Press the  print button once to specify one print for that photo. Press the button again to increase the number of prints. You can specify up to nine prints per photo. The number of prints appears with an icon  1 (through  9) in the top left corner of the LCD monitor.

Note:

- ❑ *The total number of photos to be printed is displayed in the top right corner of the LCD monitor as shown below.*



- ❑ *When the total number exceeds 99, the icon changes as shown below.*









4. To select zero prints, hold down the  print button momentarily, or push the button again if there are nine prints specified.

Making the print brightness setting

Use this setting to make your photo to look brighter when it is printed. This setting only affects the quality of the printout when you use a printer that supports the PRINT Image Matching system.

Note:

- ❑ *This setting only affects the quality of the printout when you use a printer that supports the PRINT Image Matching system.*
- ❑ *This setting does not affect the image data, or the quality of the image when it is displayed on a computer monitor.*

- ❑ The brightness of the image on the LCD monitor changes when you change the brightness setting. This approximates the effect the setting will have when printed by a printer that supports the PRINT Image Matching system.
1. Press the  button. The last photo you took appears on the LCD monitor.
 2. Select the photo you want to make brightness settings for using the  button. To select the next photo, press T. For the previous photo, press W.
 3. Press the  button repeatedly until the red frame appears around the  icon.
 4. Press the  button to make the setting. The  icon appears at the top of the LCD monitor.



Select this icon with the red frame.

Note:

To cancel this setting, press the  button again.

Resetting the number of prints to zero

If you have specified a number of prints for one of more photos in the camera's memory card, you can reset the number of prints to zero for individual photos, or for all photos at once.



See the appropriate section below for instructions.

Note:



To specify the number of prints for a selected photo, see “Selecting photos and specifying the number of prints” on page 60.

Specifying zero prints for individual photos

Follow the steps below to specify zero prints for one photo at a time.

1. Press the  button to view the photos in the camera’s memory card.
2. Use the  button to select the photo whose print setting you want to change. Press W to view the previous photo, or T to view the next photo.

Note:



- To make selecting photos easier, you can display nine photos at once. See “Displaying nine photos at once” on page 54.
 - Once you have selected a photo, you can select zero prints by holding down the print button for a few seconds.
3. After you have selected the photo, press the  button repeatedly until the red frame appears around the  icon.



Select this icon with the red frame.
 4. Press the  button to change the number of prints for the selected photo to zero. The icon and the number on the top of the LCD monitor disappear.





Specifying zero prints for all photos

Follow the steps below to specify zero prints for all photos in the memory card at once.



1. Press the  button. The last photo you took appears on the LCD monitor.
2. Press the  button repeatedly until the red frame appears around the green  icon.









Select this icon with the red frame.

3. Press the  button. The , , and  icons appear in turn.

Note:

To cancel the operation, press the  button next to the  icon.

4. Press the  button below the  icon. The  and  icons appear in turn to signify that the number of prints for all photos will be set to zero if you continue.
5. Press the function button below the  icon to change the number of prints to zero for all the photos in the memory card.
6. Press the  button.

Making Camera Settings

You can change the time and date settings, and specify the order in which date is displayed. See the following sections.

Setting the Time and Date

If the memory for the time and date are deleted, or if you want to change them, you can set them as follows.

Changing the time and date setting

Note:

- ❑ *If the batteries are removed from the camera for an extended period, the time and date settings will be erased. For instructions, see “Setting the time and date for the first time” on page 22.*
 - ❑ *The following steps show the date displayed in the month/day/year format.*
1. Slide the OPEN switch to turn the camera on.
 2. While pressing the ▲ button, press the function button.

The LCD monitor appears as shown on the right.

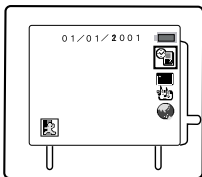

3. Press the **←** button. The date and time appear on the LCD monitor as shown on the right. The month, day, and year are displayed with the month highlighted.

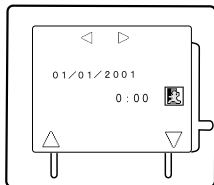

Note:

To go back, press the **←** button again.

4. Press the function button and the **▲** button to change the value of the highlighted item.
5. After you finish making settings, highlight a different item by pressing **W** and **T** on the **(W T)** button.
6. Repeat steps 4 and 5 until you finish making the date and time settings.
7. After you are finished making the date and time settings, press the **←** button.
8. Press the function button.

Note:

The flash setting may change while making the above settings. To change the flash setting back, see "Setting the flash" on page 33.

Changing the display order

You can change the order that the year, month, and day are displayed on the camera's LCD monitor. Follow the steps below.

1. Slide the OPEN switch to turn the camera on.
2. While pressing the ▲ button, press the function button.

The LCD monitor appears as shown on the right.

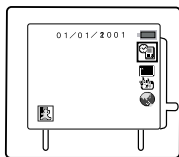

3. Press the ▲ button repeatedly until the red frame appears around the  icon.





Move the red frame to this icon.

4. Press the  button to change the order that the date is displayed. The order at the top of the LCD monitor changes as well as the selected icon. You can choose between the following orders.

Note:

The flash setting may change while making the above settings. To change the flash setting back, see "Setting the flash" on page 33.

Order of date display	Icon
Month/Day/Year	
Day/Month/Year	
Year/Month/Day	

5. After you finish making the setting, press the function button.

Note:

You must reset the time and date if the camera is unplugged and the batteries are removed for more than four days.

Setting the Beep



You can choose from three types of beep settings. Make the settings as follows and see the table for descriptions.

1. Slide the OPEN switch to turn the camera on.
2. While pressing the ▲ button, press the function button.

The LCD monitor appears as shown on the right.

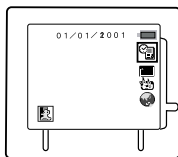



3. Press the ▲ button repeatedly until the red frame appears around the  icon.



Move the red frame to this icon.

4. Press the ← button until you see the setting you prefer.

Always		Sounds are made when you press any button on the camera, including the shutter button.
Shutter only		Sounds are made only when you press the shutter button and when you use the self timer.

Silent		No sounds are made.
--------	---	---------------------

Note:

To go back to the previous screen on the LCD monitor, press the function button.

5. After you finish making the setting, press the  button, then press the function button.

Note:

The flash setting may change while making the above settings. To change the flash setting back, see “Setting the flash” on page 33.

Chapter 5

Using Images on Your Computer

This chapter explains how to transfer your photos from the camera's memory card to your computer. The following topics are covered.

- ❑ System requirements for your computer
- ❑ Included EPSON software
- ❑ Viewing the *EPSON Digital Camera Software User's Guide* on your computer for instructions on software installation
- ❑ Connecting and disconnecting the camera to your computer

Note:

For information on using the EPSON camera software, see the online EPSON Digital Camera Software User's Guide.

For information on printing photos with EPSON PhotoQuicker, see the online EPSON PhotoQuicker User's Guide.

System Requirements

Before connecting your PhotoPC 2100Z digital camera to your computer and running the digital camera software, make sure that your computer meets the following system requirements.

For Windows

The system requirements for using the PhotoPC 2100Z with Windows are as follows:

USB port (TYPE A receptacle)

At least 48 MB RAM
(64 MB when using EPSON PhotoQuicker)

Hard disk drive with at least 50 MB of free space
(170 MB when using EPSON PhotoQuicker)

VGA monitor with at least a 256-color display

Microsoft® Windows Millennium Edition, Windows 98,
or Windows 2000 pre-installed

For Macintosh

The system requirements for using the PhotoPC 2100Z with Macintosh computers are as follows:

Power PC G3 processor or higher

Apple® Macintosh with built-in USB port

48 MB RAM
(128 MB when using EPSON PhotoQuicker together with
EPSON Photo!4)

Hard disk drive with at least 50 MB free space
(170 MB when using EPSON PhotoQuicker)

Monitor with a minimum resolution of 640 × 480

Note:

The included software cannot be used with the Multiple Users function of Mac OS 9.

Included Software

The EPSON Camera Software CD-ROM that comes with your PhotoPC 2100Z digital camera contains the following EPSON software.

- ❑ **PhotoPC 2100Z USB driver**
Driver necessary to connect your camera to your computer (except for Windows 2000 and Mac OS 9).
- ❑ **EPSON Photo!4**
Software for viewing and managing the images you capture with your PhotoPC 2100Z.
- ❑ **EPSON CameraStarter**
Utility that starts automatically when you connect your camera to your computer and provides you with a convenient way to launch EPSON AutoDownloader and EPSON PhotoQuicker.
(Automatically installed with EPSON Photo!4.)
- ❑ **EPSON AutoDownloader**
Utility that provides you with a quick and organized way to transfer your photos from the camera to your computer.
(Automatically installed with EPSON Photo!4.)

❑ **EPSON CardMonitor**

Utility that enables EPSON CameraStarter to start automatically by detecting when the camera is connected to your computer, or when the memory card is inserted into a PC Card slot.

❑ **EPSON PhotoQuicker**

Software for printing your images.

❑ **Adobe Acrobat Reader**

Software necessary for viewing the included *EPSON Digital Camera Software User's Guide*.

Installing the Software

To install the necessary software, see the online *EPSON Digital Camera Software User's Guide*. For instructions on viewing this manual, see "Accessing the EPSON Digital Camera Software User's Guide" on page 75.

Note:

Be sure to install all the software before you connect your camera to your computer.

Viewing the Software User's Guides on Your Computer

For information on installing and using the included software, view the following user's guides on your computer.

EPSON Digital Camera Software User's Guide
EPSON PhotoQuicker User's Guide

See the sections below to view these manuals.

Accessing the EPSON Digital Camera Software User's Guide

Follow the steps below to view the online digital camera software manual.

For Windows

1. Turn on the computer and insert the included PhotoPC 2100Z Camera Software CD into the CD-ROM drive.

If a dialog box prompts you to select a language, click the appropriate language, then click .

2. The EPSON Installation Program dialog box appears. Select View PDF Manual, then click .

Note:

If the EPSON Installation Program dialog box does not appear, double-click the My Computer icon. Click the CD-ROM icon, then select Open from the File menu. Then double-click Setup.exe.

3. Follow the on-screen instructions to view the manual.

Note:

If Acrobat Reader is not installed in your computer, or an out-of-date version is installed, the on-screen instructions will guide you through the installation of a current version of Acrobat Reader.

On a Macintosh

1. Turn on the computer and insert the included PhotoPC 2100Z Camera Software CD into the CD-ROM drive.

In the EPSON folder that appears on your computer's desktop, double-click the English icon.

Note:

If the EPSON folder does not appear on your desktop, double-click the EPSON icon on your desktop.

2. Double-click the Manual folder.

Note:

If Adobe Acrobat Reader is not yet installed on your computer, double-click the Acrobat Reader folder, then double-click the Reader installer icon and follow the on-screen instructions to install Adobe Acrobat Reader.

3. Double-click the EPSON Software User's Guide.PDF file to view the manual.

Accessing the EPSON PhotoQuicker User's Guide

The online EPSON PhotoQuicker User's Guide is installed automatically when you install the EPSON PhotoQuicker software. Follow the steps below to view the manual.

For Windows

Click Start, point to Programs, then to EPSON PhotoQuicker, and then click EPSON PhotoQuicker3.X User's Guide.

On a Macintosh

Double-click the EPSON PhotoQuicker3.X folder on your hard drive, then double-click the EPSON PhotoQuicker User's Manual icon.

Connecting and Disconnecting the Camera

Use the USB cable included with your camera to connect the camera to the computer. When your camera is connected, you can download or copy your photo files to the computer, or upload photo files saved in the computer to the memory card.

Connecting the camera to your computer

You can connect your PhotoPC 2100Z to a computer using the USB cable.

Before connecting your camera, make sure that the USB driver is installed in your computer (except for Windows 2000 and Mac OS 9). For installation instructions, see the online *EPSON Digital Camera Software User's Guide*.

Note:

- ❑ *Make sure the camera's batteries have enough power before connecting the camera to your computer. If the camera turns off automatically because of low battery power while connected, your computer may function incorrectly. EPSON highly recommends using the optional AC adapter whenever you connect the camera to your computer.*
- ❑ *Make sure a memory card is inserted in your camera. Otherwise, a connection will not be established.*
- ❑ *When the camera is connected to the computer, only the  button on the camera is enabled, and the camera's automatic power save feature is disabled.*
- ❑ *Although you can connect the USB cable at any time, EPSON recommends connecting it in the manner described below.*
- ❑ *If the EPSON software does not recognize the camera when it is connected, see the troubleshooting chapter in the online EPSON Digital Camera Software User's Guide for more information.*

To connect the camera, follow the steps below.

1. Turn on your computer.
2. Plug the cable connector into the USB port on your computer or the port on the USB hub connected directly to your computer.

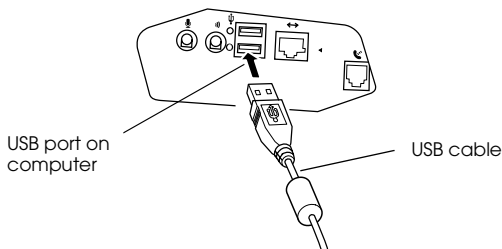

Caution:

Be sure to use the USB cable that comes with your camera to avoid damaging the camera's interface connector.

3. Open the connector cover on the side of the camera and insert the other end of the USB cable into the interface connector as shown below. Make sure that the shape of the cable connector corresponds to the shape of the interface connector.

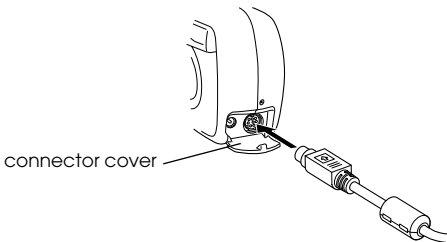

Caution:

Be sure to position the cable correctly before inserting it into the connector. Otherwise, the cable and connector may be damaged.

4. Press the  button to turn the camera on. The indicator light blinks orange.

The first time you connect your camera to your computer, various window may appear while the computer associates the USB driver with the camera. This is normal and only happens the first time the camera is connected.

If you have not yet installed the USB driver, a message asking you to locate the driver will appear. If this happens, cancel the operation and disconnect the camera from the computer. Close all applications, then install the USB driver (except for Windows 2000 and Mac OS9) following the instructions in the online *EPSON Digital Camera Software User's Guide*.

When you connect the camera, the indicator light next to the viewfinder blinks orange while the connection is being established.



Caution:

Keep your camera and computer away from potential sources of electromagnetic interference, such as loudspeakers or the base units of cordless telephones.

Note:

If the date and time need to be set, the following screen appears while connecting your camera to your computer. Press the  button to connect without setting the time and date, or see "Setting the time and date for the first time" on page 22 to make the settings.

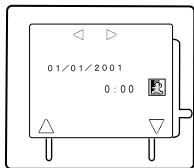

Disconnecting the camera from your computer

After you are finished using the camera with the computer, be sure to disconnect the camera correctly. Follow the steps in the appropriate section below.



Caution:

Be sure to follow these steps when disconnecting the camera. Doing otherwise may damage the camera or memory card, and could cause your computer to function incorrectly.

Disconnecting the camera in Windows Me and 98

1. Double-click the My Computer icon on the desktop. The My Computer window appears.
2. Right-click the Removable Disk icon, then click Eject. The Removable Disk icon disappears.
3. Press the  button to turn the camera off. After the indicator light goes off, disconnect the USB cable.

Disconnecting the camera in Windows 2000

1. Double-click the eject icon on the task bar.



The Unplug or Eject Hardware dialog box appears.

Note:

Alternatively, you can display the Unplug or Eject Hardware dialog box by right-clicking the eject icon, then clicking Unplug or eject hardware.

2. Click the Stop button. The Stop a Hardware device dialog box appears.
3. Select USB Mass Storage Device, then click the OK button.
4. A confirmation message appears. Click OK.

Note:

- ❑ *If the Problem Ejecting USB Mass Storage Device window appears, click the OK button and restart the operation from step 1.*
 - ❑ *You can also disconnect the camera by clicking the eject icon on the task bar once, then clicking Stop USB Mass Storage Device, and clicking OK.*
5. Press the  button to turn off the camera. The indicator light goes off.

Disconnecting the camera from a Macintosh

1. On the desktop, move the EPSON_DSC icon into the Trash.
2. Press the  button to turn the camera off. After the indicator light goes off, remove the USB cable.

Camera Options and Accessories

This chapter describes how to use the optional equipment that is available from EPSON to expand the memory and flexibility of your PhotoPC 2100Z.

The following topics are included in this chapter.

- Using CompactFlash memory card
- Using the PCMCIA adapter
- Using rechargeable batteries
- Using the AC adapter

Using Memory Cards

The PhotoPC 2100Z comes with an 8 MB CompactFlash memory card to store photos.



Caution:

- Never insert or remove a memory card from your camera while the camera is on.*
- If you want to replace a memory card when using the USB connection, eject the card inside the camera, turn the camera off, then replace it.*

Note:

A memory card must be installed in your PhotoPC 2100Z before you can take pictures. One has been installed in the camera prior to shipment. To install a memory card, see "Installing and removing a memory card" on page 16.

The following table shows the approximate photo storage capacity of the 8 MB CompactFlash memory card for the PhotoPC 2100Z's three image quality settings.

Image Quality Setting	Photo Storage Capacity
e-mail	About 115 photos
Print	About 14 photos
HyPict	About 10 photos

Note:

- ❑ *The number of photos that you can save on a memory card may differ slightly from what is shown in the chart above, depending on the complexity of each photo.*
- ❑ *For information about the availability of CompactFlash memory cards in your area, contact your EPSON dealer.*

Inserting a memory card into your computer

With a PCMCIA adapter, you can insert a memory card into any computer equipped with a Type II PCMCIA memory card slot. This allows you copy photos directly from your memory card to your computer, to copy programs from your computer to your camera, or delete programs from your memory card.

To insert the memory card in your computer, follow these steps.

1. If necessary, remove the memory card from the camera. See "Installing and removing a memory card" on page 16.
2. Insert the memory card all the way into the adapter (sold separately), as shown on the right.
3. Insert the adapter into your computer's Type II PCMCIA slot.

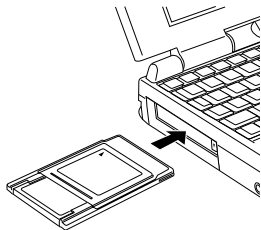
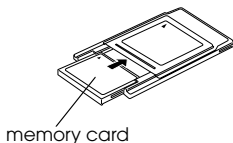

To copy photos from a memory card to your computer, see the next section.

Copying files directly from the memory card

To copy files to your computer, follow these steps.

Note:

- ❑ *When inserting the memory card into a Macintosh using the optional PCMCIA adapter, you must enable the PC Exchange extension software to access files on memory cards. See your Macintosh documentation for more information.*
 - ❑ *You can also access the files on your memory card using the included EPSON Photo!4 software. For instructions, see the online EPSON Digital Camera Software User's Guide.*
1. Connect the camera to your computer, or insert the memory card into the PC Card slot in your computer or other device.

Note:

For instructions on connecting your camera, see "Connecting and Disconnecting the Camera" on page 77. To insert the memory card into your computer, see "Inserting a memory card into your computer" on page 86. To insert the memory card into a different device, see the documentation for that device.

2. For photos, find and double-click the DCIM folder on the memory card drive. Then double-click the 100EPSON folder. Your image files are listed.

Note:

- ❑ *The PhotoPC 2100Z saves image files in the automatically generated *****EPSON** folder, where ******* represents any number from 100 to 999.*
 - ❑ *Photos that you have taken are automatically named in the order in which they were saved to the memory card. For example, EPSN0012 is the name of the twelfth photo that was saved. Photo files use the JPG format.*
 - ❑ *If the memory card in the camera has a file numbered 9999 in a folder numbered 999, you will not be able to take any pictures with the camera. In this case, format the memory card (see the next section), or use a different one to take more pictures.*
3. Double-click a file to view its thumbnail image.
 4. Copy the images to the desired folder on your hard drive.

Formatting memory cards

The included CompactFlash memory card is formatted prior to shipment. Only format a memory card when you want to delete all the data on the card or when the icons below appear in turn on the LCD monitor to signify that no more photos can be stored on the memory card.



To format a memory card, follow the steps below.



Caution:

When you format a memory card, all the data on the card is deleted, including any photos that were locked using EPSON Photo!4 or a different EPSON camera.

1. Slide the OPEN switch to turn the camera on.

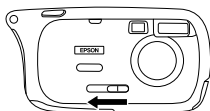

2. While pressing the ▲ button, press the function button.

The LCD monitor appears as shown on the right.

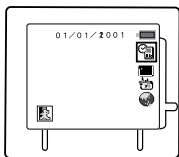

3. Press the ▲ button repeatedly until the red frame appears around the  icon.





Move the red frame to this icon.

4. Press the ◀ button. The icons below appear in turn on the LCD monitor.



Note:

To cancel formatting, press the ◀ button to the right of the  icon.

5. Press the function button under the  icon. Formatting starts.

Note:

The flash setting may change while making the above settings. To change the flash setting back, see “Setting the flash” on page 33.

Using Rechargeable Batteries

You can use Ni-MH rechargeable batteries (Model EU-24) with your PhotoPC 2100Z, instead of the included four AA (IEC LR6) alkaline batteries. The rechargeable batteries help you save time and money that you might otherwise spend buying replacement alkaline batteries. Be sure to charge your new rechargeable batteries before installing them in the camera.

Keep the following points in mind when using these batteries.

- To fully charge new batteries or batteries that have not been used for a long time, you may have to charge them two or three times.
- Use the batteries regularly so that they continue to charge well. Batteries which have not been used for a long time will not charge well, but will return to normal with regular use.
- Discharge batteries completely before recharging them. If your batteries are not completely drained of power, you may not be able to recharge them fully.

- ❑ Batteries that are charged in a hot environment wear out more quickly.
- ❑ Do not leave batteries in the camera or charger for a long time without using them. See “Storing the batteries” on page 100 for storage instructions.
- ❑ Rechargeable batteries wear out with repeated use; as their charging capacity decreases, your camera’s operating time decreases. Replace the batteries when their operation time becomes short. To dispose of old batteries, see “Disposing of batteries” on page 101.
- ❑ When the batteries are fully charged, the battery charger’s light turns off. To charge your batteries again, unplug the AC power cord, then plug it back in.

Note:

Replace the batteries with new Ni-MH batteries if the charger light stays on for more than 240 minutes or if the charger light flashes for more than half an hour.

After the light goes off, unplug the charger. To avoid overcharging, unplug the charger as soon as possible after the light goes off.

Using the AC Adapter

The AC adapter (B867**1) allows you to connect your PhotoPC 2100Z to a standard electrical outlet. This is especially useful when you are previewing pictures, transferring pictures, or making print settings. The adapter powers the camera, but does not charge the batteries. In some locations the AC adapter comes with a separate AC power cable.

Note:

- ❑ *The asterisks are substitutes for the respective digits of the product number, which vary by country.*
- ❑ *Read the AC adapter's documentation before using this product.*



Warning:

- ❑ *Only use the included AC adapter, which is designed for the PhotoPC 2100Z. Using another adapter could cause fire, electrical shock, or injury.*
- ❑ *Do not use the AC power cable or the adapter for any purpose other than powering your PhotoPC 2100Z.*
- ❑ *If the AC plug does not fit your outlet, have a proper outlet installed by a qualified electrician.*
- ❑ *To avoid radiation danger, do not expose or remove the ferrite core.*
- ❑ *To prevent fire or electric shock, do not cover the AC adapter with a blanket or similar covering that could give off an electrical charge.*

To avoid losing any images or settings, make sure that the camera is finished processing and is turned off before you connect or disconnect the AC adapter. Then follow the steps below.

1. If your AC adapter has a separate AC power cable, push the cable connector firmly into the AC inlet.

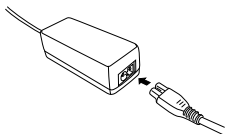

2. Open the connector cover on the side of the camera.
3. Plug the adapter cable into the AC adapter connector on the camera.

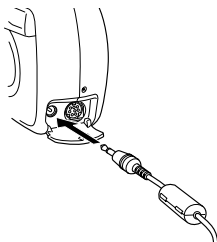

4. Plug the AC adapter into an electrical outlet.



Caution:

- ❑ *Place the camera and the AC adapter near an electrical outlet where the plug can be easily unplugged.*

Note for French-speaking users:

Placez l'appareil photographique et ses options près d'une prise de courant où la prise peut être débranchée facilement.

- ❑ *Avoid electrical outlets that are controlled by wall switches or automatic timers. Also, avoid outlets on the same circuit as large appliances that can cause fluctuations in line voltage.*

Chapter 7

Maintenance and Troubleshooting

The PhotoPC 2100Z is easy to take care of, and most problems can be solved quickly and easily.

This chapter helps you to maintain your camera and contains information on the following topics.

- ❑ Handling, cleaning, and storing the camera
- ❑ Maintaining the batteries
- ❑ Solutions for camera and image problems

Note:

See the online EPSON Digital Camera Software User's Guide for solutions to software problems.

Maintaining the Camera

Your PhotoPC 2100Z requires only basic care. Before you perform any maintenance on the camera, be sure to read the "Safety Instructions" on page 4. Then follow these guidelines.

Handling the camera

Keep the following points in mind when handling the camera.

- ❑ To avoid damaging the optics of the camera, do not expose the lens to direct sunlight for extended periods of time.
- ❑ Avoid sudden temperature changes, which can cause moisture to form on the camera and optional equipment. Keep the camera and optional equipment in a case or a bag if you need to move them from a cold environment to a warm one. Allow time for the camera and optional equipment to adjust to temperature changes before using them.

Cleaning the camera

Keep the following in mind when cleaning the camera.

- ❑ Be sure to turn the camera off before cleaning.
- ❑ Use a clean, dry cloth to keep the camera free of dust.
- ❑ Do not use harsh or abrasive cleaners.
- ❑ To clean the lens, turn off the camera. Remove the batteries and unplug the AC adapter if you are using it. Then open the lens cover and blow off any loose dust or dirt. Next, breathe on the lens and wipe off all moisture with a soft, lint-free cloth or lens cleaning tissue.
- ❑ If necessary, clean the battery contacts with a dry cloth.

Storing the camera

If you are not planning to use the camera for a long period of time, remove the batteries and store them at a low temperature in a dry location. This prevents damage to the camera from battery leaks or corrosion.



Do not store the camera in the following locations.

- Areas where it will be exposed to direct sunlight. For example, on a car dashboard
- Near sources of bright light or high humidity
- Near sources of heat or in a closed car
- In areas with excessive dirt or dust
- Areas where it will be exposed to strong vibrations or magnetic fields

Maintaining the Batteries

Cleaning the batteries

Follow the instructions in this section when cleaning the batteries.

Dirty contact points (\oplus and \ominus) on the batteries and inside the battery cover can obstruct the flow of electricity in your camera. This can cause the , , and  icons to appear and disable all the buttons on your camera, even if there is still power remaining in your batteries.

To prevent this kind of power loss, keep the contact points (⊕ and ⊖) on the batteries and inside the battery cover clean. When necessary, wipe them with a soft, dry cloth.

If you are using a battery charger, clean the terminals of the battery charger with a soft, dry cloth before use to ensure that your batteries charge fully.



Caution:

- ❑ *Do not use detergents or chemical solvents such as thinner, benzine, or alcohol-based solutions to clean your camera, batteries, or battery charger. Doing so can damage your equipment.*
- ❑ *Never attempt to clean the inside of the battery compartment of your camera. Doing so can damage your camera.*

Keep the battery ends clean by wiping them with a dry cloth.



Warning:

Do not disassemble, drop, or short-circuit batteries. Do not apply heat or force to batteries, or bring them into contact with fire or water.

Storing the batteries

If you do not plan to use the camera for a long period of time, remove the batteries and store them in a dry location at a low temperature.

**Warning:**

- Do not store batteries together with metal objects, which could short-circuit the batteries.
- Avoid storing batteries in extremely hot or humid locations.
- Store batteries out of reach of children.
- Always remove the batteries from the camera and charger before storing. Batteries left in your camera and charger for a long time could leak and cause damage.

Disposing of batteries

Before disposing of batteries, make sure you discharge them completely.

**Warning:**

- Be sure to securely cover the + end of each battery with tape when disposing of them to prevent combustion or explosion.
- Dispose of used batteries according to the manufacturer's instructions and in compliance with all applicable laws. Contact your local government agency for information about battery recycling and disposal.

For users in Europe:



Do not dispose of batteries as ordinary refuse. Instead, dispose of them in a collection or recycle box in accordance with local laws.

Problems and Solutions

Refer to this list of problems and possible solutions before calling your dealer for help.

Camera problems

The following are problems that you may encounter while using your camera.

Error and status icons

You may see some icons on the LCD monitor that inform you of some errors or your camera's status. See the table below.



If no buttons are operated for several minutes, your camera will enter standby mode. A countdown (3 2 1) will appear on the LCD monitor before the camera enters standby mode. Press any button to exit standby mode.



These icons appear in turn when no more photos can be stored on the memory card. Turn off the camera and either replace the memory card or transfer the photo data to your computer, then delete the photos from the memory card. To transfer photos, see the *EPSON Digital Camera Software User's Guide*. To delete photos, see "Deleting Photos" on page 56, or "Formatting memory cards" on page 89.



These icons appear in turn when a memory card is not installed in your camera. No buttons will function. Turn off the camera, then insert a memory card. For instructions on installing a memory card, see “Installing and removing a memory card” on page 16.



These icons appear in turn when your camera requires time to process data. No buttons will function until these icons have disappeared.



These icons appear in turn if the batteries in your camera are out of power. Replace the batteries with new ones. See “Installing and replacing the batteries” on page 18.



These icons appear in turn if there is a problem with the memory card in your camera. Try formatting the card (the photos in the card will be erased), or replace the old card with a new one. To format the card, see “Formatting memory cards” on page 89.





The camera has no power.



The camera may have shut off automatically to save power. To turn the power back on, press the  button, or slide the OPEN switch to turn the camera off and then turn it on again.

Make sure that the batteries are installed correctly. See “Installing the batteries” on page 19. Also, make sure that you are using appropriate batteries and that they are charged. See “Replacing the batteries” on page 21, and replace the batteries if necessary.

If you are using the AC adapter, make sure that it is plugged into a working outlet.

The camera does not take a picture when you press the shutter button.

Make sure that the memory card is installed correctly. Check the picture on the LCD monitor. If the  and  icons appear in turn, install a memory card. See “Installing and removing a memory card” on page 16.

The camera’s memory card may be full. Check the picture on the LCD monitor. If the  and  icons appear in turn, your memory card cannot store any more photos. Delete some pictures using the LCD monitor, or transfer the pictures to your computer and then delete them.

Note:

To delete pictures using the LCD monitor, see “Deleting Photos” on page 56. To transfer pictures to your computer before deleting them, see the online EPSON Digital Camera Software User’s Guide.

The camera may be connected to your computer. When it is connected, you can use only the  button. For more information, see “Connecting and Disconnecting the Camera” on page 77.

The camera takes too long to take a picture.

You may be pressing the shutter button all the way down at once. This forces the camera to focus, make exposure adjustments, and capture the image all at the same time. To make the process more efficient, you can have the camera perform these operations separately. First, depress the shutter button halfway to lock the auto focus, then press the shutter button the rest of the way down to take the photo. For more information, see “Taking Pictures Using the LCD monitor” on page 31 or “Taking Pictures Using the Viewfinder” on page 47.

The flash does not work.

Make sure that your flash is not set to  (flash off). See “Setting the flash” on page 33 for details on setting the flash.

Make sure that the batteries are installed correctly. See “Installing the batteries” on page 19. Also, make sure that you are using appropriate batteries and that they are charged. See “Replacing the batteries” on page 21.

The lens is still extended even though the camera is turned off.

The batteries may be low. Use the optional AC adapter, or replace the batteries with new or recharged batteries, then turn the camera on and off again. The lens retracts.

Nothing appears on the LCD monitor.

Make sure that the batteries are installed correctly. See “Installing the batteries” on page 19. Also, make sure that you are using appropriate batteries and that they are charged. See “Replacing the batteries” on page 21.

The camera may have shut off automatically after standby mode to save power. To turn the power back on, press any button.

The LCD monitor is turned off. Press the MENU button.

Note:

The LCD monitor shuts off automatically when connected to the computer.

The image on the LCD monitor is not visible at all.

Make sure that the LCD monitor is turned on. Press the MENU button.



Note:



The LCD monitor shuts off automatically when connected to the computer.

You cannot take certain kinds of pictures or make the settings that you want when using the viewfinder.

Some of the camera’s settings and features cannot be used at the same time. For example, you cannot use the macro feature or the digital zoom feature when you take pictures using the viewfinder.

You cannot take a picture with the camera when a memory card is installed.

Check the picture on the LCD monitor. If  and  appear in turn, replace the memory card with a correct one. See “Installing and removing a memory card” on page 16.

The camera’s memory card may be full. Check the picture on the LCD monitor. If the  and  icons appear in turn, your memory card is full. Delete some pictures using the LCD monitor, or transfer the pictures to your computer and then delete them.

Note:

- ❑ *The PhotoPC 2100Z saves image files in the automatically generated ***EPSON folder, where *** represents any number from 100 to 999.*
- ❑ *The folder name begins with a three digit number, from 100 to 999. The file name includes a four digit number, from 0001 to 9999, and ends with the JPG extension.*
- ❑ *The above icons also appear when there is a folder in the memory card numbered 999 that contains a file numbered 9999. In this case, format the memory card, or use a different one to take more pictures.*
- ❑ *To delete pictures using the LCD monitor, see “Deleting Photos” on page 56. To transfer pictures to your computer before deleting them, see the online EPSON Digital Camera Software User’s Guide. To format the memory card, see “Formatting memory cards” on page 89.*

Even after you take a picture, the number on the LCD monitor stays the same.

This number shows how many more pictures you can take. The number may not change, depending on the image quality or the complexity of the photos you take.

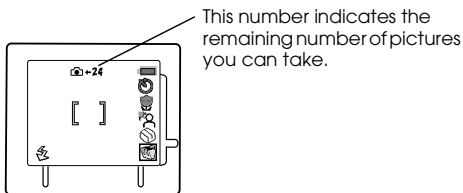

Picture problems

If you are not satisfied with the photos that you get from your PhotoPC 2100Z, you may need to adjust some of the camera's settings, or you may need to brush up on your photography techniques. Try the suggestions listed below.

The photo on the computer screen and/or printout differs in quality from the image displayed on the LCD monitor.

The PhotoPC 2100Z captures images in 24-bit color (16 million colors). Your photos will not be displayed at maximum image quality if your monitor or your computer's video controller does not support this color depth. You may need to upgrade your system to achieve the best possible image quality.

If the image on the LCD monitor and computer screen are different, check the gamma correction and color correction settings. Try a different combination of these settings.



If your photos look better on the computer screen or LCD monitor than when you print them out, you may need to upgrade your printer. EPSON color ink jet printers provide excellent image quality.

Your picture is blurry or out of focus.

Observe the following:

- Make sure that the subject is not moving.
- Hold the camera steady while the image is being captured.
- Make sure that your flash is not set to  (off).
- Center your subject in the LCD monitor. When you take photos using the viewfinder, center your subject in the focus frame.
- When using the macro feature, you can position the camera 30 to 50 centimeters away from the subject.

Your picture is too dark (underexposed).

You may need to use the flash. Set the flash to  (auto) or , following the instructions given in "Changing the flash setting."

Use image-editing software to adjust the picture's brightness and contrast.

When you use the built-in flash, make sure that you are within the effective flash range of 50 to 320 centimeters for a wide-angle shot, and 50 to 230 centimeters for a telephoto shot. When using the macro feature, you can position the camera 30 to 50 centimeters away from the subject.

If you are using the macro feature to take close-up photos, be sure to provide adequate lighting for your subject, since the camera's aperture is automatically set to the smallest setting.

Your picture is too light (overexposed).

When you use the flash and the macro feature together, you may find that your pictures come out too light, since the flash is close to the subject. In this case, try setting the flash to  (off).

If you are facing a bright light source, you may need to take your picture from a different angle.

Use image-editing software to adjust the picture's brightness and contrast.

Part of your picture is missing.

Make sure that you are not blocking the lens with your finger, the strap, clothing, or other objects.

The wrong date and/or time is displayed on your camera.

If you remove the batteries from your camera for a certain period of time, you may need to reset the clock. See "Setting the Time and Date" on page 65 to set the clock using the LCD monitor.

The color in your photos does not look right.

When you take pictures under certain artificial lighting conditions, the colors may be slightly distorted. You can use image-editing software to adjust the color.

When you want to get more realistically colored images (for example, reddish images at dusk), set the white balance. For instructions, see “Using the white balance feature” on page 46.

Your pictures do not look as good as they used to.

Your camera’s lens may be dirty or dusty. Try cleaning it, following the instructions in “Cleaning the camera” on page 98.

The area captured in the photo is different from what you saw in the viewfinder.

Take care to look straight through the viewfinder.

When taking photos using the macro setting, be sure to use the LCD monitor. You cannot use the viewfinder with the macro setting.

Keep in mind that the area visible through the viewfinder is slightly smaller than the area captured in the actual photo.

Appendix A

Specifications

Camera

Model G871A

Physical dimensions

Width	130 mm (The width including the strap protrusion is 146 mm)
Height	73 mm
Depth	46.7 mm
Weight	265 g (without batteries, memory card, and strap)
Temperature	Operating: 5 to 35°C Non-operating: -20 to 60°C
Humidity (non-condensing)	Operating: 30 to 80% Non-operating: 10 to 80%

Product type

Type	Digital still AF camera with LCD monitor
CCD	1/2.6 inch color area CCD (2.18 megapixels – effective picture element)
Zoom	Optical $\times 2$ zoom Digital $\times 2.5$ zoom
LCD monitor	1.6-inch D-TFD color LCD monitor (approximately 55 K pixels)
Memory card	CompactFlash memory card

Recorded image

Data types	JPEG image following Exif Ver.2.1 and recorded based on The Design rule for camera file system (16 million colors, 24 bit)
	Note: <i>Exif is a standard format for audio/image files. The Design rule for camera file system is a recording standard for image files. These standards have been established by the Japan Electronics and Information Technology Industries Association (JEITA).</i>
Image quality modes (image size)	HyPict 2160 × 1440 pixels Print 1800 × 1200 pixels e-mail 720 × 480 pixels
Alternative formats	Macro, digital × 2.5 zoom

Optical

Lens	f = 5.6 - 11.2 mm (equivalent to a 35 - 70 mm lens on a 35 mm camera) F3.3 (5.6 mm) - F4.5 (11.2 mm)
Focal length (AF area)	0.5 m to infinity 0.3 to 0.5 m (macro mode)
Focus	Auto focus
Sensitivity	Automatically adjusting type From ISO 100 to ISO 200
Aperture	F3.3 and F6 (W)
Shutter	1/8 to 1/1000 when the flash is off 1/2 when the low-light condition setting is used
Exposure control	Center selective photometry system program auto
White balance	TTL automatic white balance Fixed (sunlight)
Viewfinder	Real-image optical (view range approx. 85%)
Self timer	Ten seconds

Flash Built-in automatic luminance control flash

Flash modes Automatic, flash off, red-eye reduction

Built-in flash range

Range 0.5 to 3.2 m (Wide)

0.5 to 2.3 m (Tele)

Functional

Photo processing time in seconds (approximate)

Image quality mode	Photo processing time	Photo processing time to view
e-mail	5	3
Print	8	9
Hypict	15	10

Interface

USB Max. 12 Mbps (for the USB cable)

Power

Sources

DC 1.5 V × 4 (6 V)

When using the included alkaline batteries.

DC 1.2 V × 4 (4.8 V)

When using Ni-MH batteries
(model EU-24)

DC 7.0 V

When using the optional AC adapter
(model EU-40)

Battery life

When using the four included alkaline batteries and taken under conditions determined by EPSON.

Taking photos using Over 145 photos
the LCD monitor

Taking photos using the Over 1000 photos
View Finder

Viewing photos Approx. 210 min.

Optional Battery Charger

Model EU-38

Input	AC 100 - 240 V, 50 - 60 Hz
Output	DC 1.2 V 490 mA × 4
Compatible batteries	EPSON Ni-MH Batteries (Model EU-24)
Charging time	Max. 240 min.
Power consumption	8 W
Charging temperature	5 to 35°C
Dimensions	76 × 115 × 28 mm
Weight	Approx. 130 g

Optional Battery

Model EU-24

Type name	Cylindrical sealed Nickel-Metal Hydride rechargeable battery
Type	SBA HR6 IEC HR15/51
Size	AA / IEC LR6 compatible
Ratings	DC 1.2 V
Temperature	Charging: 5 to 35°C Storage: -20 to 30°C
Humidity	45 to 85% RH
Weight	Approx. 25 g per cell

PCMCIA Adapter

Interface	PCMCIA PC Card ATA
Card slot type	Type II
Physical Dimensions:	
Width	54.0 mm
Height	85.6 mm
Depth	5.0 mm

Optional AC Adapter

Model EU-40

Input AC 100 - 240 V, 50 - 60 Hz

Output DC 7.0 V, 2.0 A

Power consumption Max. 0.4 A, 19 W

Physical Dimensions:

Width 43 mm

Height 31 mm

Depth 104 mm

Weight Approx. 210 g
(Without AC power cord)

A**Specifications**

Icons That Appear on the LCD Monitor



A variety of icons appear on the LCD monitor at different times to help you use your camera, and to inform you of the camera's status.

See the following sections for information on the icons that appear when you take pictures and make settings, and when the camera needs help.

Note:

You can turn off the icon display when taking or viewing pictures by pressing the MENU button.

When Taking Pictures

When you turn the camera on to take pictures with the LCD monitor, a red tool box  appears on the bottom right of the monitor. This tool box contains many "tools," or icons that represent certain camera features. To open the tool box and use these features, press the  button. The icons appear, along with a bag  that contains even more icons.

With the tool box open

The remaining number of pictures you can take.

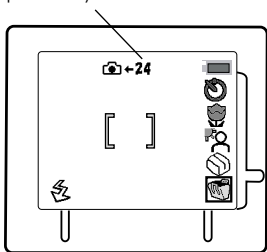



 Shows the approximate amount of remaining battery power.

 For using the self timer. See page 36.

 For using the macro feature to take close-ups. See page 38.

 For taking pictures against a backlight. See page 39.

 For accessing more features. See page 125 for the icons that appear when you open this bag.

 Red tool box from which the above icons emerge.



Shows the current flash setting. See "Setting the flash" on page 33.

With the bag open

The remaining number of pictures you can take.

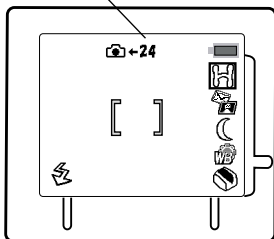



 Shows the approximate amount of remaining battery power.

 For making HyPict resolution setting. See page 40.

 For making the e-mail size resolution setting. See page 42.

 For taking pictures in low-light conditions. See page 44.

 For making the white balance setting. See page 46.

 Bag from which the above icons emerge.



Shows the current flash setting. See "Setting the flash" on page 33.

When using the zoom feature

Appears when the zoom feature is being used. Shows the current optical zoom level. See page 35.

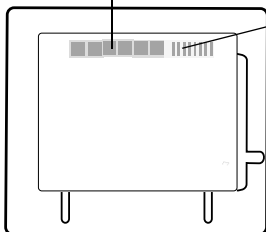

Appears only when the digital zoom is being used. Shows the current digital zoom level. See page 35.

Note:

To use the zoom when taking pictures with the viewfinder, see "Using the optical zoom feature" on page 51.

When specifying the amount of prints after taking a picture

Number of prints specified for the currently displayed photo. See page 60.

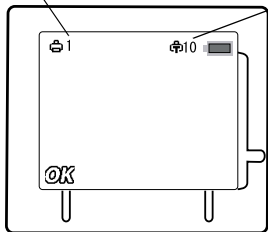

Shows the total number of photos to be printed. See page 60.



Shows the approximate amount of remaining battery power.

OK Appears after you take a picture. See page 31.

When Viewing Photos

When you turn the camera on to view photos with the LCD monitor, a tool box  appears on the button right of the monitor. This tool box contains many “tools,” or icons that represent certain features to help you view and manage your photos. To open the tool box and use these features, press the  button and the icons appear above the tool box.

With the tool box open

The number of the currently selected photo. To select a different photo, see page 53.

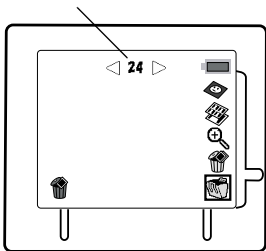

 (blue) For deleting the currently selected photo. See page 56.

 Shows the approximate amount of remaining battery power.

 For making the print brightness setting. See page 61.

 For displaying nine photos at once on the LCD monitor. See page 54.

 For magnifying the currently displayed or selected photo. See page 55.

 (green) For deleting all photos at once. See page 57.

 Tool box from which the above icons emerge.

B

Icons That Appear on the LCD Monitor

When magnifying a photo

 Shows which part of the photo is displayed. See page 55.

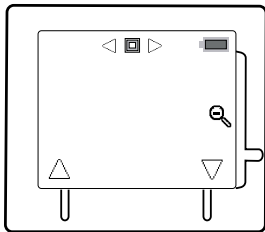

 Shows the approximate amount of remaining battery power.

 To quit using the magnifying feature. See page 55.

 To move to the upper part of the magnified photo. See page 55.

 To move to the lower part of the magnified photo. See page 55.

(Use the  button to scroll right and left)

When there are no photos in the memory card

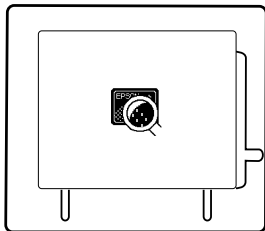

 Shows there are no photos in the camera's memory card.

When specifying the amount of prints

Number of prints specified for the currently selected photo.

The number of the currently selected photo.

Total number of prints to be made.

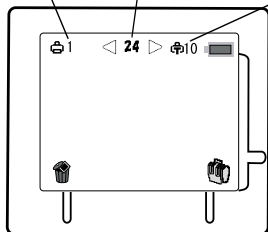

 Shows the approximate amount of remaining battery power.

 Tool box from which other icons emerge.



For deleting the currently selected photo. See page 56.

B

Icons That Appear on the LCD Monitor

When selecting zero prints

Number of prints specified for the currently selected photo.

The number of the currently selected photo.

Total number of prints to be made.

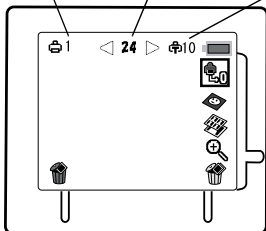



 Shows the approximate amount of remaining battery power.

 For specifying zero prints of the displayed photo. See page 62.

 For making the print brightness setting. See page 61.

 For displaying nine photos at once on the LCD monitor. See page 54.

 For magnifying the currently displayed or selected photo. See page 55.

 This blue icon is for deleting the currently displayed photo. See page 56.





 This green icon is for deleting all photos at once. See page 57.

When Making Camera Settings

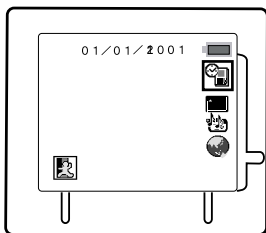
See the following sections for brief explanations of the icons that appear on the LCD monitor when you make date and time settings and beep settings, and when you format the memory card.

Camera setting menu



-  Shows the approximate amount of remaining battery power.
-  For making date and time settings. See page 65.
-  For formatting memory card. See page 89.
-  For setting the beep. See page 69.
-  For changing the way the date and time are displayed. See page 67.



To go back to the preview screen.

When setting the date and time

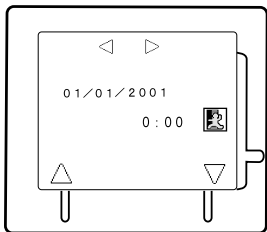

To go back to the previous screen. See page 65.



For increasing the value of selected item. See page 65.



For decreasing the value of selected item. See page 65.

(Use the  button to scroll right and left)

When formatting the memory card

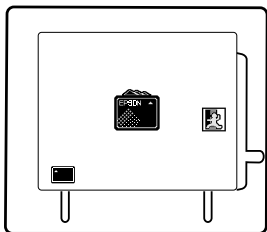

Indicates that you are about to format the memory card. See page 89.









To go back to the previous screen and cancel formatting the memory card. See page 89.

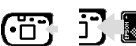

To format the memory card. See page 89.

Status and Error Icons

See the following sections for brief explanations of icons that appear on the LCD monitor to tell you the camera's status or to alert you to a problem.

	Warns you that the automatic shut-off feature has been triggered. See page 102.
	Alerts you that the memory card cannot store any more photos. See page 102.
	Alerts you that the memory card is not installed in your camera. See page 102.
	Warns you that your camera requires time to process the data. See page 102.
	Alerts you that the battery power is low. See page 102.
	Alerts you that an error has occurred in the memory card. See page 102.

B**Icons That Appear on the LCD Monitor**

Glossary

application

A software program that helps you carry out a particular task, such as word processing, image editing, or financial planning.

bit

Short for binary digit. The smallest unit of data in computer processing. A bit can represent two values: on and off, or 1 and 0.

browser (Web browser)

An application which allows users to view HTML documents.

default

A value or setting that takes effect when the equipment is turned on, reset, or initialized. Also known as a factory setting.

Design rule for camera file system

Recording standard for image files. Established by the Japan Electronics and Information Technology Industries Association (JEITA).

DPOF

Digital Print Order Format. Settings for the number of prints and for index prints are saved in a DPOF file on the camera's memory card. You can apply these settings when using a printer or printing application that supports the DPOF standard.

Exif2.1

Standard format for audio/image files. Established by the Japan Electronics and Information Technology Industries Association (JEITA).

exposure

The amount of light the camera captures when a photo is taken.

image

Data representing a two-dimensional scene. A digital image is composed of pixels arranged in a rectangular array with a certain height and width. Each pixel may consist of one or more bits of information, representing the brightness of the image at that point.

ink jet printer

A printer that transfers ink onto paper by spraying ink through a number of small nozzles.

interface

A piece of hardware, a method, or a standard used to connect the computer and the camera.

JPEG

A file format for storing color and grayscale images in compressed files. Data saved using the JPEG format generally receives greater compression than data saved using TIFF and other formats.

macro

An enlargement or a close-up of an image.

pixel

Short for picture element. Each image is composed of a number of pixels. Pixels are also counted in units of dots.

port

An interface channel through which data is transmitted between devices.

PRINT Image Matching

A new standard that allows digital cameras to record special information about the photos it takes and relay that information seamlessly to a printer compatible with this standard. This information can be used by printers that support the PRINT Image Matching system for enhanced printing results.

resolution

An indication of how finely an image is resolved into pixels. See *pixel*.

thumbnails

Small representations of images.

white balance

The balance between the whiteness and color in your image. When the white balance is fixed to the environment where the picture is taken, the colors in your images appear more like those seen by the eye.

zoom

To show a smaller area of an image at a higher magnification (zoom in) or a larger area at a lower magnification (zoom out).

Index

A

- AC adapter, 3
 - connector, 13
 - specifications, 121
- AC power cord, 12
- Activating the shutter, 32
- Auto shut-off, 30

B

- Batteries
 - checking, 21
 - disposing of, 101
 - handling, 99
 - installing, 19
 - low battery icon, 15
 - specifications, 120
 - storing, 100
- Battery charger, 3, 12
 - specifications, 119
- Battery cover, 14
- Beep sound, 69

C

- Cables
 - see* USB cable

- Camera
 - cleaning, 98
 - connecting to your computer, 78
 - disconnecting from your computer, 82
 - handling, 98
 - physical dimensions, 113
 - storing, 99
- Camera indicator lights, 15, 81
- Checking
 - batteries, 21
 - picture counter, 104, 107
- Cleaning
 - camera, 98
- CompactFlash
 - memory card, 12
 - copying images from card to computer, 88
 - formatting, 89
 - installing in your camera, 16
 - removing from your camera, 18
 - storage capacity, 86
- Connecting the camera to your computer, 78
- Copying images, 88
- Cover
 - battery, 14
 - memory card, 14

D

- Deleting
 - all photos, 57
 - individual photos, 56
- Digital zoom, 35
- Disposing of batteries, 101

F

- Flash, 13
 - range, 117
- Formatting memory cards, 89

I

- Icons
 - error and status, 102
 - flash, 15
 - low battery, 15, 21
 - self timer, 15
- Indicator light, 14, 15, 32, 81
- Installing
 - batteries, 19
 - memory card in camera, 16

L

- LCD monitor, 14
- Lens, 13
- Lights
 - indicator, 14, 15, 32
 - timer, 13

M

- Memory card
 - see* CompactFlash memory card
- MENU button, 14

N

- Ni-MH rechargeable batteries, 3, 12

O

- OPEN switch, 30
- Optical specifications, 116
- Options, 3
 - AC adapter, 121

P

- PCMCIA adapter, 3
 - specifications, 120
- Pictures
 - see* Photos
- Photos
 - copying, 88
 - processing time, 117
 - recorded image
 - specifications, 115
- Physical dimensions, 113
- Playing back photos
 - using the magnification feature, 55

R

Rechargeable batteries, 3, 12
Removing memory card from
camera, 18

S

Safety instructions, 4
Settings
 beep, 69
Specifications
 AC adapter, 121
 battery, 120
 battery charger, 119
 optical, 116
 PCMCIA adapter, 120
Storing
 the batteries, 100
 the camera, 99
System requirements
 for Macintosh, 72
 for PC, 72

T

Timer
 light, 13
 using, 36
Tripod, 14

U

United Kingdom users
 use of options, 4
Unpacking your camera, 12
USB
 cable, 78, 82, 83
 driver, 73
 interface connector, 13
Using
 shutter button, 32

V

Viewfinder, 14
Viewfinder front, 13

Z

Zoom, 35, 51

EPSON OVERSEAS MARKETING LOCATIONS

Epson America, Inc.

3840 Kilroy Airport Way
Long Beach, CA 90806
Phone: (562) 981-3840
Fax: (562) 290-5220

EPSON UK LTD.

Campus 100, Maylands Avenue,
Hemel Hempstead, Herts,
HP2 7TJ, U.K.
Phone: (+44) 01442 261144
Fax: (+44) 01442 227227

EPSON DEUTSCHLAND GmbH

Zülpicher Straße 6,
40549 Düsseldorf Germany
Phone: (0211) 56030
Fax: (0211) 5047787

EPSON FRANCE S.A.

68 bis, rue Marjolin
92300, Levallois-Perret, France
Phone: 33.1.41.86.26.56
Telex: 610657

EPSON AUSTRALIA PTY. LTD.

70 GIBBES STREET,
CHATSWOOD 2067 NSW.
Phone: 2-9903-9000
Fax: 2-9903-9177

EPSON SINGAPORE PTE. LTD.

No. 1 Temasek Avenue #36-00
Millenia Tower, Singapore 039192
Phone: (065) 33 77 911
Fax: (065) 33 41 185

EPSON HONG KONG LTD.

Rooms 4706-10, 47/F,
China Resources Bldg.,
26 Harbour Road, Wanchai,
Hong Kong
Phone: 2585-4300
Fax: 2827-7083

EPSON TAIWAN TECHNOLOGY & TRADING LTD.

10F, No. 287 Nanking E. Road, Sec. 3,
Taipei, Taiwan, R.O.C.
Phone: (02) 717-7360
Fax: (02) 712-9164

EPSON ITALIA S.p.A.

V.le F.lli Casiraghi 427
20099 Sesto S.Giovanni
MI, Italy
Phone: +3902262331
Fax: +39022440750

EPSON IBERICA S.A.

Av. de Roma, 18-26
08290 Cerdanyola del Valles
Barcelona, Spain
Phone: 582. 15.00
Fax: 582. 15.55

SEIKO EPSON CORPORATION (Hirooka Office)

80 Harashinden, Hirooka
Shiojiri-shi, Nagano-ken
399-0785 Japan

EPSON PORTUGAL, S.A.

R. do Progresso, 471, 1° Perafita
4460 Matosinhos, Portugal
Phone: (02) 996 14 02
Fax: (02) 996 14 11

EPSON

Digital Camera



PhotoPC 2100Z *User's Guide*

Printed in XXXX
XX.XX-XX